

Wireless World

RADIO AND ELECTRONICS

AUGUST
1949

39th YEAR OF PUBLICATION

Proprietors: LILFE & SONS LTD.
Managing Editor: HUGH S. POCKOCK, M.I.E.E.
Editor: H. F. SMITH

Editorial, Advertising and Publishing Offices:
DORSET HOUSE, STAMFORD STREET,
LONDON, S.E.1.

Telephone: Waterloo 3333 (60 lines).
Telegrams: "Ethaworld, Sedist, London."

PUBLISHED MONTHLY

Price: 2/-

(Publication day: last Thursday of preceding month)

Subscription Rate: 26/- per annum. Home and Abroad

Branch Offices:

Birmingham: King Edward House, New Street, 2.
Coventry: 8-10, Corporation Street.
Glasgow: 26B, Renfield Street, C.2.
Manchester: 260, Deansgate, 3.

In This Issue

OUR COVER: Testing Television Sets (See Page 316)

EDITORIAL COMMENT	281
HIGH-QUALITY AMPLIFIER: NEW VERSION By D. T. N. Williamson	282
SHARED TELEVISION AERIALS	287
TEST REPORT: PHILIPS MODEL 681A	289
TELEVISION MOVING IMAGES By R. W. Hallows	291
AUDIO SIGNAL GENERATOR By M. G. Scroggie	294
ELECTRONIC CIRCUITRY By J. McG. Sowerby	298
WORLD OF WIRELESS	301
TELEVISION RECORDING By D. A. Smith	305
MILLER EFFECT By "Cathode Ray"	307
BIRMINGHAM TELEVISION RECEPTION	312
UNBIASED By "Free Grid"	314
LETTERS TO THE EDITOR	315
SHORT-WAVE CONDITIONS	317
RANDOM RADIATIONS By "Diallist"	318
RECENT INVENTIONS	320

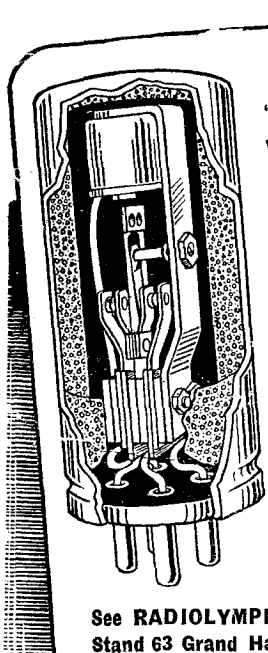

"Stratosil" fully sealed vibrators are supplied in synchronous, non-synchronous and split-reed synchronous types. Being available in both shunt and series drive (the latter being made under "OAK" patents) they offer a replacement service for the majority of American-pattern vibrators as well as covering fully the needs of the designer of new equipments.

See RADIOLYMPIA Stand 63 Grand Hall



VIBRATORS

set the standard for efficiency

A data book, complete with replacement guide and transformer design information is now ready and will be gladly sent to you at 6d. post free. Please use the coupon.

POST THE COUPON NOW

Wright & Weaire, Ltd., 138 Sloane Street,
London, S.W.1, England
Please send me VIBRATOR DATA BOOK for which I enclose 6d.
Name and Address

vw 849

Wright and Weaire Limited

138, SLOANE ST. LONDON S.W.1 TEL SLOANE 22145 FACTORY: SOUTH SHIELDS, CO. DURHAM

Wireless World

VOL. LV. NO. 8

AUGUST 1949

RADIO AND ELECTRONICS

Comments of the Month

BROADCASTING FOR EXPORT

FOR a long time there has been growing dissatisfaction over the low field strength provided by the broadcasting service in certain areas of the country, notably the South Coast. Last month a reader made what seems to be an eminently practical suggestion: that the Kingston station, near Brighton, should be used, at such times as it is not carrying out its normal function of distributing the Third programme, for reinforcing the Home and Light programmes over an area that is notoriously badly served.

Many readers now protest that this suggestion, though useful, offers merely a palliative. It is pointed out that the supplementary service would not be available at night-time, when, during the summer, atmospherics are most likely to spoil reception of the long-wave station. The real cause of the trouble, it is contended, is that the B.B.C. is using two of its medium-wave channels exclusively for broadcasting to Europe, and not for the internal service. Here it should perhaps be added that one of the channels in question is "borrowed" and is not one of those officially allocated to this country under the Lucerne Plan. But, as a reader whose letter is printed elsewhere in this issue points out, the avowed intention of the B.B.C. is to use two of the medium-wave channels given to Great Britain under the Copenhagen Plan, including one of our three exclusive (non-shared) frequencies for the European Service. Thus it would seem that medium-wave broadcasting for export is to become a semi-permanent activity.

The general idea is, of course, one with which we have become uncomfortably familiar of late years: the exporting of something we need ourselves. The parallel is not quite perfect, and in any case, most of the issues raised cannot be commented upon here. It is permissible, however, to say that our correspondent is probably right in assuming the frequencies given to us at Copenhagen were for home consumption: it seems unlikely that the delegates of

all the countries represented there agreed on our having extra channels, over and above our domestic requirements, for propagating our ideas abroad. And it also seems to follow that, at future conferences, we shall find it difficult to sustain claims for the number of channels enjoyed at present if it can be shown we evidently can do without some of them for home consumption.

One conclusion is clear. If the Government decides that medium-wave channels that are in fact necessary for a good home service are to be permanently used for other purposes, it is more than ever desirable that the development of a supplementary e.h.f. service should proceed at all speed. As to whether a.m. or f.m. will be used for the service will presumably depend on the results of the B.B.C.'s forthcoming full-scale tests.

TELEVISION PICTURE QUALITY

AN article elsewhere in this issue will serve to draw attention to the fact, of which there is growing recognition, that definition as expressed in the number of scanning lines is not the only quality that goes to make a satisfactory television picture. One of the novel views put forward is that, so far as reproduction of moving objects is concerned, it might be better to reduce the number of lines and increase the number of frames. This and other suggestions of the author, though ingenious, call for experimental verification before they can be accepted.

In view of our editorial comments last month on the relative merits of British and American television standards, we were particularly interested in our contributor's suggestion that the U.S. practice of using 60 frames per second (as opposed to our 50) might give less distortion of rapidly moving images. If he is proved to be right, we may have to modify our statement, though we stick to our original contention that the 60-per-second rate was chosen to fit in with the standard American supply frequency.

HIGH-QUALITY AMPLIFIER

Since the "Williamson" amplifier, as it has come to be called, was first described in our issues of April and May, 1947, it has aroused world-wide interest. In the Australian *Radiotronics* (Nov.-Dec., 1947) it was described as "by far the best we have ever tested. . . . It not only gives extraordinary linearity and lack of harmonic and intermodulation distortion, but is comparatively simple. . . ." The present article repeats the original design data, with slight modifications, and deals at length with special precautions to be taken

SINCE the publication in the April and May, 1947, issues of this journal of an amplifier design suitable for high-quality reproduction of sound, correspondence has revealed that a more complete explanation of

mand exists for a pre-amplifier unit to enable the amplifier to be used in conjunction with gramophone pickups and microphones of low output. In the present article it is proposed to deal with the amplifier, and in a subsequent

necessity for frequent reference to the May, 1947, issue, the circuit of the amplifier and the list of component values are printed again. These differ in minor detail from the originals. In the circuit previously printed a potentiometer was provided in the penultimate stage to enable the signal to be balanced. Due to the use of common unbypassed cathode resistors for the push-pull stages, the amplifier is largely self-balancing to signal, and it is permissible to dispense with this adjustment. Accordingly, revised values and tolerances are shown for resistors R_5 , R_7 , R_{11} and R_{13} .

A transitional phase-shift network consisting of R_{26} and C_{10} ,

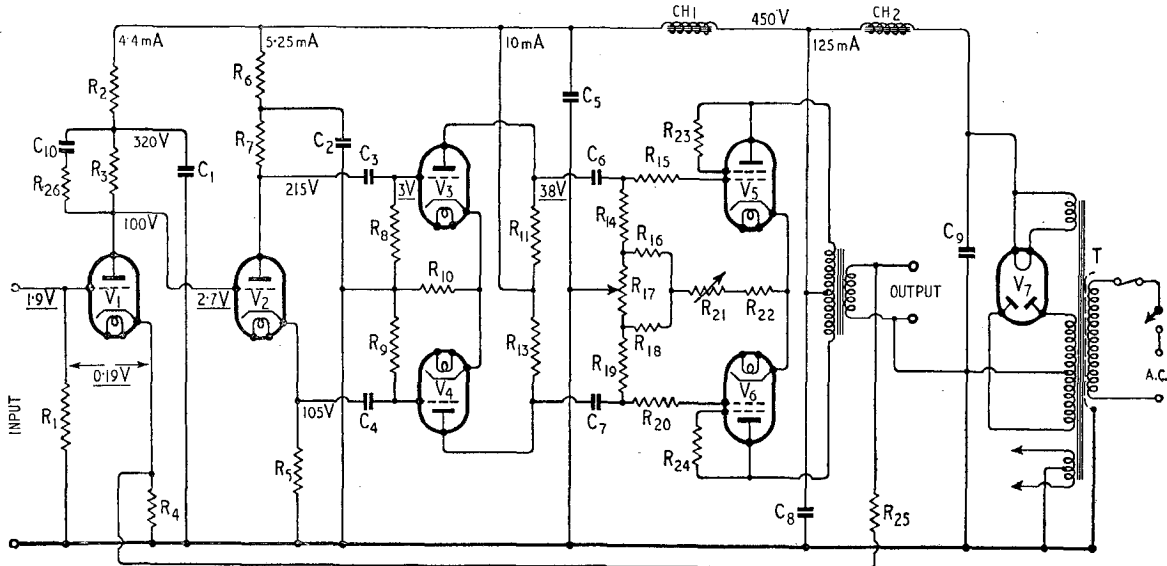

Fig. 1. Circuit diagram of complete amplifier. Voltages underlined are peak signal voltages at 15 watts output.

R_1	1M Ω	$\frac{1}{4}$ watt \pm 20%
R_2	33,000 Ω	1 watt \pm 20%
R_3	47,000 Ω	1 watt \pm 20%
R_4	470 Ω	$\frac{1}{4}$ watt \pm 10%
R_5, R_7	22,000 Ω	1 watt \pm 5%
	(or matched)	
R_6	22,000 Ω	1 watt \pm 20%
R_8, R_9	0.47M Ω	$\frac{1}{4}$ watt \pm 20%
R_{10}	390 Ω	$\frac{1}{4}$ watt \pm 10%
R_{11}, R_{13}	47,000 Ω	2 watt \pm 5%
	(or matched)	

R_{14}, R_{15}	0.1M Ω	$\frac{1}{4}$ watt \pm 10%
R_{15}, R_{20}	1,000 Ω	$\frac{1}{4}$ watt \pm 20%
R_{16}, R_{18}	100 Ω	1 watt \pm 20%
R_{17}, R_{21}	100 Ω	2 watt wirewound
		variable
R_{22}	150 Ω	3 watt \pm 20%
R_{25}	1,200	$\sqrt{\text{speech coil impedance}}$
		$\frac{1}{4}$ watt (see table)
R_{26}	4,700 Ω	$\frac{1}{4}$ watt \pm 20%
C_1, C_2, C_5, C_8	8 μ F	500V wkg.
C_3, C_4	0.05 μ F	350V wkg.

C_6, C_7	0.25 μ F	350V wkg.
C_9	8 μ F	600V wkg.
C_{10}	200pF	350V wkg.
CH ₁	30H	at 20mA
CH ₂	10H	at 150mA
T	Power transformer	
	Secondary 425-0-425V 150 mA, 5V. 3A, 6.3V 4A, centre-tapped	
V_1, V_2	2 \times L63 or 6J5, 6SN7 or B65	
V_3, V_4	do. do.	
V_5, V_6	KT66	
V_7	Cossor 53KU, 5V4	

some of the features of the design, with the addition of some information about construction, would be of interest. The correspondence also shows that considerable de-

article to present the design of auxiliary equipment to form a domestic sound-reproducing installation.

Circuit Diagram. To avoid the

which was previously recommended as a temporary measure, has been added as a permanent feature to increase the margin of stability at high frequencies. This

New Version

Design Data : Modifications : Further Notes

By **D. T. N. WILLIAMSON** (*Ferranti Research Laboratories*)

will be discussed later when the stability of the amplifier is considered.

Finally, an indirectly - heated rectifier has been substituted as this prevents a damaging voltage surge when the amplifier is switched on. No suitable type was available when the circuit was originally published. A list of alternative valve types is also shown.

Amplitude and Phase/frequency Response. A curve showing the transmission and loop gain of the amplifier at frequencies between 1 c/s and 1 Mc/s is shown in Fig. 2. Although only the section between 10 c/s and 20,000 c/s is useful for sound reproduction, the curves outside this range are included as they may be of interest to those who may wish to use the amplifier for other purposes. They may also serve to emphasize that, in a feedback amplifier, the response must be carefully controlled at frequencies very remote from the useful range if stability is to be achieved.

Many different arrangements have been used satisfactorily to suit differing circumstances. An excellent plan is to construct the power supply and the amplifier on separate chassis, as this gives greater flexibility in accommodating the equipment in a cabinet.

The following

Fig. 3. Suggested layout of principal components of combined amplifier and power pack.

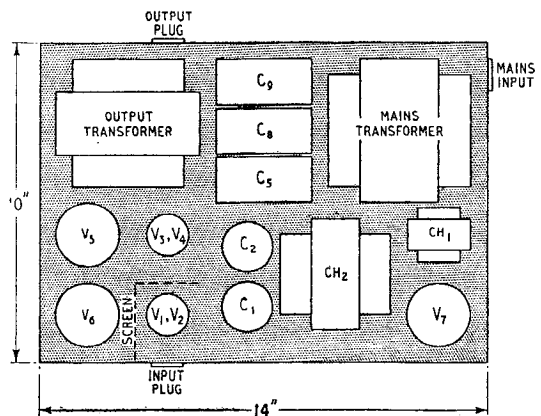

- precautions should be observed:—
1. The output transformer core should be positioned at right angles to the cores of the mains transformer and the main smoothing choke.
 2. The output transformer and loudspeaker leads should be kept

able gain at low radio frequencies, and care is necessary to avoid oscillation.

3. Signal wires, especially grid leads, should be kept as short as possible, and the stopper resistors associated with the output stage must be mounted on the valve-holder tags, and not on group panels.

4. A bus-bar earth return formed by a piece of 12 or 14 s.w.g. tinned copper wire, connected to the chassis at the input end, is greatly to be preferred to

the use of the chassis as an earth return.

5. Electrolytic and paper capacitors should be kept away from sources of heat, such as the output and rectifier valves.

Figs. 3 and 4 show the positions of the major components in two

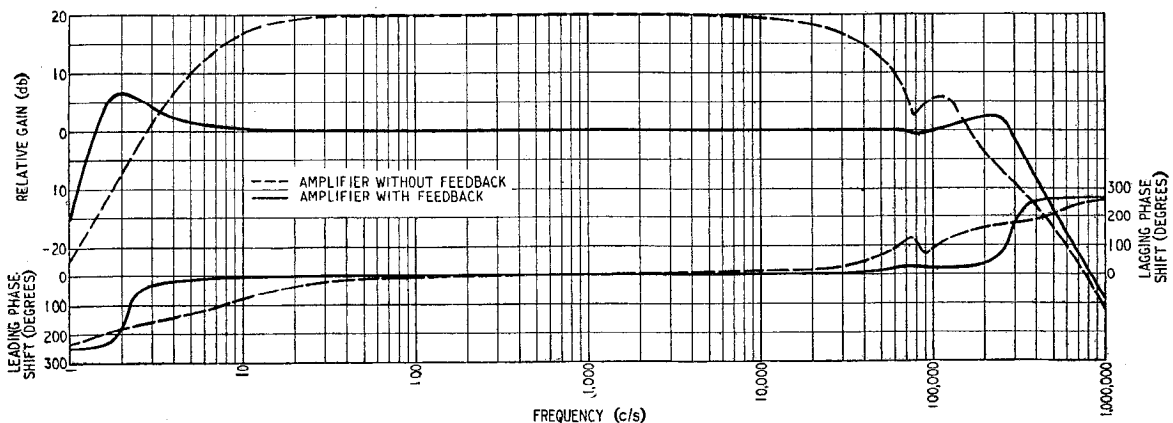

Fig. 2. Loop gain and phase-shift characteristics of the amplifier.

General Constructional Data. The layout of the amplifier is not critical, provided that a few simple precautions are observed.

at a reasonable distance from the input leads, which should be screened. As the response curve shows, the amplifier has consider-

alternative layouts which have been used successfully.

Initial Adjustments. Before the amplifier is put into service

High-Quality Amplifier—

there are a few adjustments which require to be made. These concern the balancing of the standing currents in the output stage, and (with the original circuit) balancing of the signal currents in the push-pull stages.

Accurate balance of the standing currents in the output stage is essential, as the low-frequency characteristics of the output trans-

put voltage about half maximum.

(d) Adjust R_{12} for minimum output in the detector.

The Output Transformer. As stated previously, the output transformer is the most critical component in the amplifier and satisfactory performance will not be obtained with a component differing substantially from the specification. The effect of de-

it is considerably larger than the transformers which are usually fitted to 15-watt amplifiers. The fact that the peak flux density of 7,250 gauss for maximum output at 20c/s lies on the upper safe limit for low distortion is sufficient comment on current practice.

Some confusion arose regarding the method of connection of the transformer secondary windings to match loads of various impedances, whilst utilizing all the secondary sections. The correct primary load impedance is $10,000\Omega$ and as the turns ratio in the original design is 76:1 the impedance of each secondary section is $10,000\Omega/76^2$ or 1.7Ω . When secondary sections are connected in parallel, the turns ratio, and hence the impedance ratio, remains unchanged. If now two secondary sections, or sets of paralleled sections, are connected in series the turns ratio is halved, and the secondary impedance, being proportional to the square of the turns ratio, becomes $1.7 \times 2^2 = 6.8\Omega$. Similarly if three sections are connected in series the impedance becomes $1.7 \times 3^2 = 15.3\Omega$. Thus the available secondary impedances, keeping a $10,000\Omega$ primary load impedance, are 1.7, 6.8, 15.3, 27, 42.5, 61, 83 and 109 Ω . The connections to obtain these values are shown in the table.

Should it be necessary, in an emergency, to match loads of other impedances to the amplifier, it is permissible to reduce the primary load impedance to $6,000\Omega$ giving another series of secondary impedances, namely 1, 4, 9, 16, 25, 36, 49 and 64 Ω . Under these conditions the power output will be increased slightly and the distortion will be doubled. The value of the feedback resistor R_{25} must remain unaltered, as the turns ratio is unchanged. The values of R_{25} are given in the table.

Winding data for an output transformer to match loads in the region of 3.5 Ω are given in the Appendix and the connections and other data are included in the lower section of the table.

The two outer layers of the output transformer primary should normally be connected together to form the centre tap, the inner sections of the winding being taken to the valve anodes. This gives

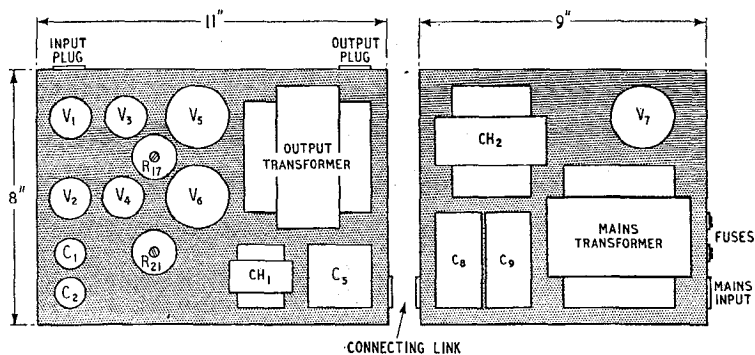

Fig. 4. Layout when using separate power pack.

former deteriorate rapidly with d.c. magnetization. The procedure to be adopted for static and signal balancing is as follows:—

Static Balancing.

(a) Connect a suitable milliammeter in the lead to the centre tap of the output transformer primary.

(b) Set the total current to 125 mA by means of R_{21} .

(c) Connect a moving-coil voltmeter (0-10 V approx.) across the whole of the output transformer primary and adjust R_{17} , until the reading is zero, indicating balance. Random fluctuations of this instrument may be noticed. These are due to mains and valve fluctuations and should be disregarded.

Signal Balancing.

(a) Connect the low-impedance winding of a small output transformer in the lead to the centre tap of the output transformer. Connect a detector (headphones or a cathode-ray oscillograph if available) to the other winding, earthing one side for safety.

(b) Connect a resistive load in place of the loudspeaker.

(c) Apply a signal at a frequency of about 400 c/s to the amplifier input to give an out-

creasing the primary inductance will be to produce instability at low frequencies, which can be cured only by altering the time constants of the other coupling circuits, or by decreasing the amount of feedback. At high frequencies the situation is more complex, as there are more variables. The leakage inductance, the self-capacitance of the windings, the capacitance between windings and the distribution of these parameters determine the transmission of the component at high frequencies, and great variations are possible.

In the output transformer specified, the only parameter which is likely to vary appreciably is the inductance of the primary at low signal levels, due to the use of core material with a low initial permeability, or to careless assembly of the core. The high-frequency characteristics are not dependent on the core material to a substantial degree. They are dependent only on the geometry of construction, and to some extent upon the dielectric properties of the insulants used, and are therefore reproducible with a high degree of accuracy.

Comments are frequently expressed about the size of the output transformer. It is true that

the minimum external electric field.

Stability with Negative Feedback.—Much has been written about the stability of amplifiers under conditions of negative feedback, and the criteria for stability are now widely appreciated. The article by "Cathode Ray" in the May, 1949, issue, states the matter simply and with characteristic clarity.

Continuous oscillation will occur in a feedback amplifier if the loop gain—that is the transmission of the amplifier and the feedback network—is greater than unity at any point where the phase shift of the amplifier has reached 180°. It is also possible for an amplifier to be unstable in the absence of continuous oscillation if these conditions should occur in a transient manner at a critical signal level. This latter condition is particularly likely to occur in badly designed amplifiers with iron-cored components, where the inductance and, therefore, the time constant



than those of the fixed coupling circuits, an increase in its value due to a high signal level may be sufficient to render the system unstable. In order to avoid this condition the fixed time constants must be made much longer than that of the variable stage. This condition would lead to undesirably large interstage couplings if good low frequency response were required. Alternatively, the variable time constant must be chosen in relation to the fixed time constants, such that its minimum value is sufficiently longer than the fixed values to produce stability. An increase in its value then serves only to increase the stability margin. This method is used in the amplifier under discussion.

To ensure a wide margin of stability, whilst at the same time preserving the high loop gain necessary to reduce the effect of transformer distortion at frequencies of the order of 10-20 c/s, would require a transformer with

to the lowest practicable value.

When the amplifier is reproduced, the "spread" in tolerance of components will normally be such that changes in characteristics due to departure from the nominal value of one component will be balanced by opposite changes produced by departure in another component, and the amplifier as a whole is likely to have characteristics close to the average. Individual amplifiers may, however, have characteristics which differ substantially from the average, due to an upward or downward trend in the changes produced by component deviations. If the trend is in a direction such that the loop gain is reduced, no instability will result, the only effect being a slight degrading of the performance. If, on the other hand, the loop gain is increased by an amount greater than the margin of stability, oscillation will occur. It should be emphasized that this will happen only very

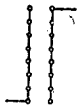
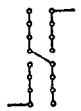
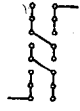
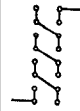
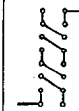
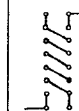
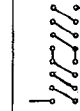
OUTPUT TRANSFORMERS. TABLE OF CONNECTIONS.

		No. of secondary groups of sections in series	1	2	3	4	5	6	7	8
		Connections								
Original Output Transformer 10,000/1.7Ω	Correct secondary impedance (ohms)		1.7	6.8	15.3	27	42.5	61	83	109
	Minimum secondary impedance permissible (ohms)		1	4	9	16	25	36	49	64
	Feedback resistor R ₂₅ (ohms)		1,500	3,300	4,700	6,800	8,200	10,000	11,000	12,000
	Turns ratio		76	38	25.4	19	15.2	12.6	10.8	9.5
Alternative Output Transformer (See Appendix) 10,000/3.6Ω	Correct secondary impedance (ohms)		3.6	14.4	32.5	57.5	90	130	176	230
	Feedback resistor R ₂₅ (ohms)		2,200	4,700	6,800	9,000	11,500	13,500	16,000	18,000
	Turns ratio		52.5	26.25	17.5	13	10.5	8.75	7.5	6.5

controlling the phase and amplitude characteristics of one or more stages may increase by as much as a factor of five between zero and maximum signal levels. If this variable time constant is shorter

a very large initial primary inductance. This would necessarily be expensive, and a compromise must be drawn between the three factors. Because of this, the margin of stability must be kept

rarely, and when it does the remedy is obviously to reduce the loop gain to its correct value.

To assist the unfortunate few who experience instability, the following procedure is recom-

High-Quality Amplifier—

mended. If oscillation should occur at a low frequency (about 2c/s) the first step should be to disconnect the feedback resistor R_{25} . If the oscillation continues the decoupling circuits should be checked and any faulty components replaced. The amplifier should also be examined to ensure that it is operating correctly balanced in push-pull, and not in an unbalanced manner due to the failure of some component.

Primary Inductance

Assuming that the amplifier is, or has been rendered, stable with the feedback disconnected, the next step should be to check the phase and amplitude characteristics at low frequencies. It is not practicable to make direct measurements of these characteristics without very special equipment, as inspection of Fig. 2 will show that the interesting region lies below 10c/s. It is therefore necessary to arrive at the desired result by indirect means, namely by measurement of the component parameters which determine the characteristics. The parameter which is most likely to show a large deviation from specification is the initial primary inductance of the output transformer, since the quality of the core material is not easy to control accurately, and careless assembly of the core may cause considerable variations in its permeability.

The initial primary inductance should be checked by connecting the primary winding across the 5-V, 50-c/s rectifier heater winding of the mains transformer and measuring the current in it. The secondary windings should be open circuit. The current, which can just be read on the 10mA a.c. range of a Model 7 Avometer, should be 150 μ A or lower. The component should be rejected if the current exceeds 200 μ A.

If the output transformer is satisfactory the values of the other components should be checked, particular attention being paid to the coupling components. Should the time constants of the couplings, that is their RC product, be higher than the nominal values by more than 20 per cent, the resistors should be adjusted to give the correct value.

The trouble will probably have

revealed itself by this time, but, if upon reconnecting R_{25} the oscillation is still present, it is very likely to be due to the use of valves with mutual conductances higher than average, and it is legitimate to increase the value of R_{25} to reduce the loop gain. If instruments are available, the loop gain may be measured by disconnecting R_{25} from the cathode of V_1 , and reconnecting it via a $470\Omega \pm 10$ per cent resistor to chassis. The voltage gain, measured from the input grid to the junction of R_{25} and the 470Ω resistor, should be 10 at frequencies between 30c/s and 10kc/s. Care must be taken not to overload the amplifier when this measurement is being made.

The adjustment of the loop gain to its correct value at medium frequencies should render the amplifier stable at high frequencies. It is unlikely that the phase characteristic at high frequencies of individual amplifiers will deviate appreciably from normal unless the layout is very poor or the transformer is not to specification.

Capacitive Loads

The amplifier is absolutely stable at high frequencies with a resistive or inductive load, but it is possible for oscillation to occur when the load impedance is capacitive at very high frequencies, for example, when a long cable is used to connect the amplifier and loudspeaker. To avoid this possibility, and to give an increased margin of stability, a transitional phase-shift network consisting of R_{26} and C_{10} in conjunction with the output resistance of V_1 , has been included in the circuit. This has the effect of reducing the loop gain at frequencies from 20kc/s upwards without affecting the phase shift in the critical region.

The use of a phase advance network consisting of a capacitor shunting R_{25} has been advocated as a means of stabilizing this amplifier. The effect of such a network is to increase the loop gain at high frequencies, at the same time reducing the amount of phase lag. It is sometimes possible by this means to steer the phase curve away from the 180° point as the loop gain is passing through unity, thus increasing the margin of stability.

The connection of a capacitor across R_{25} , however, will not stabilize this amplifier if it has been constructed to specification, although it may produce improvement if oscillation is due to some large departure from specification, such as the use of an output transformer with completely different high-frequency characteristics. The writer has no information about this.

The use of separate RC bias impedances for the output valves has also been suggested. This procedure is not endorsed by the writer, as there are numerous disadvantages in its use and no redeeming features whatsoever. If the time constant of the bias network is made sufficiently long to ensure that the low-frequency performance of the amplifier is unimpaired, the phase shift of the bias network will have its maximum at or near the lower critical frequency and may provoke oscillation. If, on the other hand, it is made sufficiently short to avoid this, the ability of the amplifier to handle low frequencies will be impaired. The use of separate bias impedances destroys the self-balancing properties of the amplifier, and if two dissimilar valves are used in the output stage "motor boating" is likely, due to the presence of signal in the h.t. line. The performance of the output transformer may be seriously affected by the out-of-balance current caused by valves whose anode currents lie within the manufacturer's tolerance limits. Finally, there can be little justification of this modification on economic grounds, as the costs are roughly similar. Indeed, if the question of replacement due to failure is considered, the common bias arrangement shows a definite saving.

It is to be hoped that these remarks on stability will not have the effect of frightening those who already possess amplifiers of this type or are contemplating acquiring them. Their purpose is to help the occasional "outer limit" case where instability is experienced, but if they serve to impress upon the reader that negative feedback amplifiers are designed as an integral unit, and that any modifications, however insignificant they may appear, may seriously affect the performance or

stability, a useful purpose will have been accomplished. Such modifications should be attempted only by those who are confident that they know what they are doing, and who have access to measuring equipment to verify results.

APPENDIX

Output Transformer with 3.6-ohm Secondaries

Winding Data

Core: 1½in. stack of 28A Super Silcor laminations. (M. & E.A.) The winding consists of two identical interleaved coils each 1½in. wide on paxolin formers 1½in. × 1½in. inside dimensions. On each former is wound :

5 primary sections, each consisting of 440 turns (5 layers, 88 turns per layer) of 30 s.w.g. enamelled copper wire interleaved with 2 mil. paper.

alternating with

4 secondary sections, each consisting of 84 turns (2 layers, 42 turns per layer) of 22 s.w.g. enamelled copper wire interleaved with 2 mil. paper.

Each section is insulated from its neighbours by 3 layers of 5 mil. Empire tape. All connections are brought out on one side of the winding, but the primary sections may be connected in series when winding, two primary connections only per bobbin being brought out. Windings to be assembled on core with one bobbin reversed, and with insulating checks and a centre spacer.

circuit is to connect two receivers to one aerial. Then $n = 2$ and $R = Z_0/3 = 24 \Omega$ if $Z_0 = 72 \Omega$ as is usual. Each receiver input is 6 db below the aerial output. The resistors can be the ordinary small composition type and in this instance it would be convenient to use for each two 47- Ω components in parallel, since this would permit the use of standard-value components.

The matching unit can be connected at any convenient point. Where it is desired to operate several receivers simultaneously in the same room, as in a demonstration showroom, the unit would obviously be fitted where the aerial feeder enters the room and short lengths of feeder run from it to each set. On the other hand, a pair of semi-detached houses might decide to share an out-door aerial. It might then be desirable to fit the matching unit fairly close to the aerial and run separate long feeders from it into the separate houses. In this case the unit must be carefully weather-proofed.

The unit can equally well go

SHARED TELEVISION AERIALS

Methods of Feeding Several Receivers

IT is not always realized that it is a simple matter to operate more than one television receiver from a single aerial. There is, of course, a loss of signal, for in the ideal case the signal power provided by the aerial is divided equally among the receivers connected to it. The loss is rarely a serious one, however, except in areas of low field strength

The most obvious way of connecting several sets to a common aerial is by means of a transformer, for then there is no loss in the network, apart from some unavoidable transformer loss. This is shown in Fig. 1 and if each receiver is designed for a feeder impedance Z_0 and the aerial feeder impedance is also Z_0 the trans-

turns ratio of $1 : N = 1 : \sqrt{1/n}$. Ignoring transformer losses, the input to each individual receiver is to log n db below the aerial output.

Where only a few sets

are used it is much simpler to use a resistance matching network, but it is rather less

efficient. The arrangement is shown in Fig. 2. It can be seen by inspection that for proper matching it is necessary to have

$$Z_0 = R + \frac{Z_0 + R}{n}$$

whence

$$R = Z_0 \frac{n - 1}{n + 1}$$

The aerial current divides equally among the receivers, there-

fore the input power to each is 20 log n db below the aerial output. The power lost in the resistors is as much as that fed to the receivers.

The commonest use of this

in the middle of a cable run. Thus, two flats on different floors might share an aerial, and the obvious place for the unit is at the entry point of the cable into the upper of the two.

Since the loss of signal for two sets is 6 db the scheme may be inapplicable in fringe areas. There is, however, the possibility that if two neighbours combine they could for the cost of two separate aerials, erect one more elaborate and lofty structure which would provide an increase of more than 6 db in signal. However, the transformer matching system

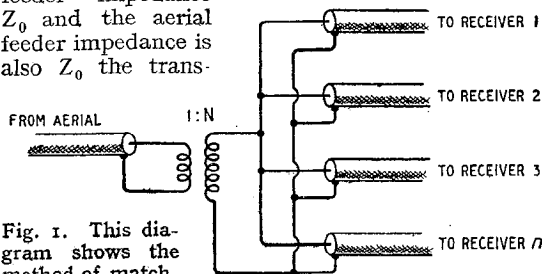

Fig. 1. This diagram shows the method of matching a feeder to several receivers by a transformer.

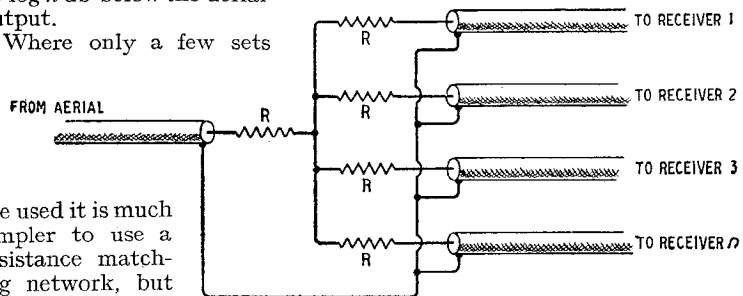

Fig. 2. Here a resistance network is used for matching several receivers to an aerial.

Shared Television Aerials—

is likely to be more satisfactory under this condition.

For two receivers the unit has the form shown in Fig. 3 (a). An alternative form which is exactly equivalent is shown in Fig. 3 (b). By the star-delta transformation

since it is obviously inapplicable to coaxial feeders. One resistor R_1 is still needed. The aerial feeder is properly matched without it and as it is connected to points of equal potential there is no current in it and no power loss in it. It is needed to retain proper

vides a 1,000-c/s modulating tone for calling the shore station. A simple code will be used to distinguish between stations operating in the same channel.

The coast stations are assembled in the standard 19in wide racks and give about 50 watts r.f. output. Unit construction is adopted for ease of maintenance and a complete unit, transmitter, receiver or power supply, can be quickly replaced if a failure occurs.

Under development is a further set intended for installation on board ships. It will give about 10 watts r.f. output and provide a considerably greater range than the lightweight portables. It will be

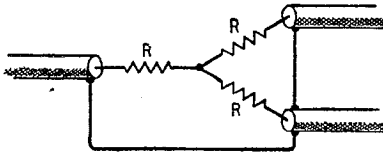

(a)

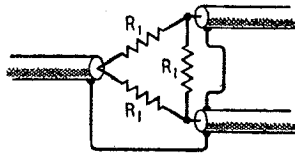

(b)

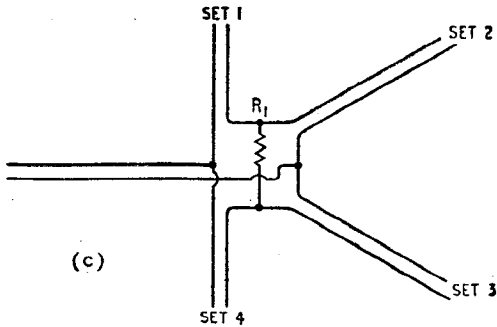

(c)

Fig. 3. When two receivers only are fed from a common aerial the circuit of Fig. 2 reduces to (a) and this has the exact equivalent (b) in which R_1 equals the feeder impedance. If twin feeders are used two of the resistors can be replaced by feeders (c) and four sets fed without extra loss.

theorem $R_1 = 3R = Z_0$. Therefore, the resistor and the feeder impedances are the same. Hence, two of the resistors could be replaced by feeders and so four sets could be operated without any loss.

This scheme is sketched in Fig. 3 (c) for twin-wire lines,

matching looking in from the receiver feeders.

It should be noted that none of the receiver feeders is balanced to earth in this arrangement, but the aerial feeder is. Such a unit should, therefore, be used only when but short connections to the receivers are needed.

HARBOUR RADIO

Supplementary Aid to Radar Navigation

A v.h.f. radio telephone system is being installed by the Mersey Docks and Harbour Board in order to provide direct communication between the port radar station* or docks and the pilots on board ships entering or leaving the river.

Initially 150 portable sets and 10 fixed shore stations will be employed. The portable sets are battery operated, weigh just under 20lb and are designed to provide a working range of up to 25 nautical miles.

Twelve radio channels have been allocated to this service, six for the portable sets in the band 158.6 to 159.1 Mc/s and six for the land

stations covering 163.6 to 164.1 Mc/s.

The portable sets are crystal controlled and any channel can be selected merely by turning a switch. A 5-Mc/s i.f. is used and as this is arranged to be the difference between the transmitting and receiving frequencies of each set the same crystals can be used for both the transmitter and the receiver. A 4-volt accumulator powers the set and the r.f. output to the aerial is 0.25 W, amplitude modulation being employed.

An important feature of the set is its simplicity of operation. There are three controls only, a channel selector, combined on-off and send-receive switch and a ringing key. The last mentioned is a novelty for this type of equipment and it pro-

Portable v.h.f. radio telephone used by pilots of the Mersey Docks and Harbour Board for ship - to - shore communication.

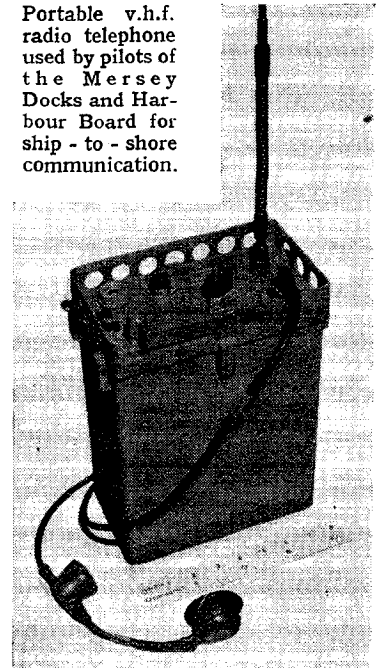

flexible enough in design to cover the United Kingdom harbour requirements as well as general radio-telephone communications between ships and from ship to shore in foreign harbours.

The equipment is designed by British Telecommunication Research and made by the Radiogramophone Development Co.

"High-Quality Audio Amplifiers"

THIS 20-page booklet containing reprints of five *Wireless World* articles on amplifier design is now available from our Publisher, price 2s 6d (postage 2d). The circuits included are "W.W. Quality Amplifiers," "A.C./D.C. Quality Amplifier," Jeffrey's "Push-Full Phase-Splitter," Baxandall's "High-Quality Amplifier Design" and Woodville's "Economical 50-watt Amplifier."

* See "Harbour Radar," *Wireless World*, September, 1948, pp. 317-320.

TEST REPORT

PHILIPS MODEL 681A

Double Frequency Changing on Short Waves

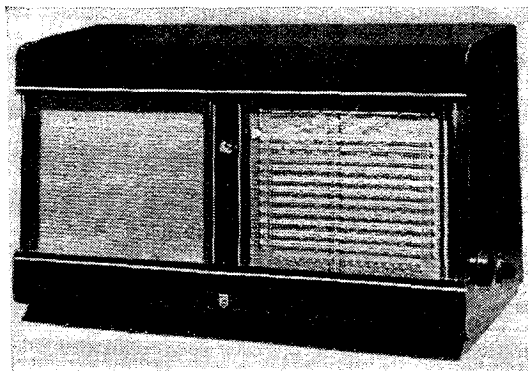

UNUSUAL care has been taken in the design of this table model receiver to provide ease and stability of tuning on short waves. In addition to the usual medium- and long-wave ranges and two short-wave ranges covering 11 to 110 metres, which are covered by the basic superheterodyne circuit consisting of r.f. amplifier, frequency changer, i.f. amplifier, detector and a.f. stages, there are eight selected short-wave broadcast bands of about 0.5 Mc/s which are each expanded to the full width of the 7-inch horizontal tuning scale. A double superheterodyne principle has been applied to the bandspread circuits in such a manner that the local oscillator on each band works at a single fixed frequency and is therefore easier to stabilize.

On the bandspread ranges the section of the main ganged tuning condenser associated with the input to the r.f. stage is discon-

FEATURES
 Waveranges:
 Normal Tuning:
 11.1—34.2 m.
 34.2—110.5 m.
 192—560 m.
 900—2,000 m.
 Bandsread ; 11, 13, 16, 19, 25, 31, 41 and 49 m. bands.
 Power Output : 8.9 watts.
 Mains Supply ; 100-250 V., 50-100 c/s.
 Consumption ; 85 watts at 220 V.
 Price (including tax) £48 8s 9d.

of the auxiliary frequency changer. The r.f. stage is fixed-tuned to a point in the middle of the band and will accept, without appreciable attenuation, signals up to 250 kc/s on either side of the centre frequency. The oscillator section of the first frequency changer is also fixed-tuned to a frequency 3 Mc/s higher than the centre point of the r.f. tuned circuits. Other signals in the band produce a spectrum of frequencies, centred on 3 Mc/s, and this first intermediate band is

signals follow the same course as on other wave ranges.

Fig. 1 shows the circuit arrangement of the two frequency changers on the bandspread ranges. The filter circuit in series with the primary of the first i.f. transformer is included for whistle suppression. Fig. 2 shows the progress of the signal through the receiver on the bandspread ranges.

As the first oscillator is higher in frequency than the signals, the calibration of the scales on the bandspread ranges is opposite to that on the normally tuned broadcast ranges. Wavelength decreases as the pointer moves from left to right, instead of increasing as on the long-, medium- and general-coverage short-wave bands.

The i.f. amplifier, detector and

Fig. 1. Circuit arrangement (without switching) of frequency changers on the bandspread ranges.

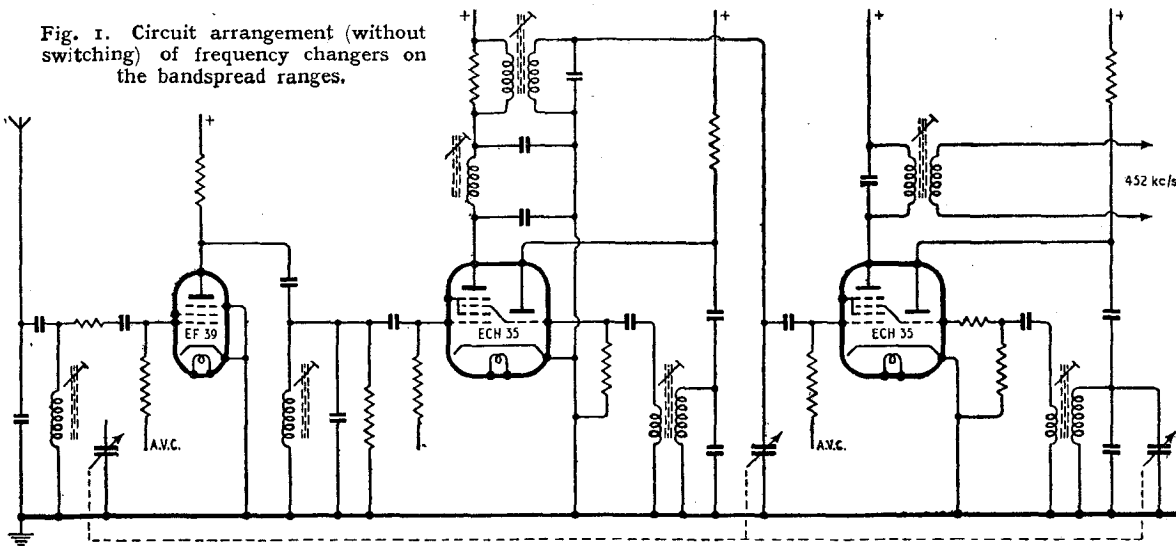

nected, and the second section tuning the intervalve coupling is transferred to a first intermediate-frequency transformer in the anode circuit of the mixer section

explored by the tuned secondary circuit connected to the grid of the second frequency changer. Here the conversion is made to the main i.f. of 452 kc/s and the

a.v.c. stages follow standard practice and a cathode-ray tuning indicator, controlled by the a.v.c. bias, is included.

A centre-tapped auto-trans-

Philips Model 681A

former couples the triode a.f. amplifier to the push-pull pentode output valves, and Fig. 3 gives the circuit arrangement of the stage. To balance out hum in the push-pull circuits R_1C_1 is introduced to offset RC. Feedback is applied from the secondary of the output transformer to one side of the phase-inverting circuit.

Tone control is effected by feedback through a capacitance from the anode to the grid of the first a.f. stage. A potential divider, which includes the tone control resistance, is connected across the phase-splitting inductance, and values are chosen so that the point X is at the same a.f. potential as the grid of the valve. When the slider is at this end of the control there is no feedback, and maximum high-note response is obtained.

Performance. — On the bandspread ranges the set handles like an ordinary broadcast receiver on medium waves—except that there are more stations to choose from and there is less overlapping. Each station can be tuned in to the mid-point of its bandwidth as easily as the local station, and if the ear does not give this point clearly, it can be found quite accurately by observing the cathode-ray tuning indicator with its two-stage sensitivity.

The set is remarkably free from self-generated whistles on all wavebands and the sensitivity and selectivity enable any station above background noise to be well received. On the bandspread

ranges the scales are accurately calibrated in both metres and megacycles and a check at several points showed that the gradua-

the back of the set and a large proportion of the top area of the chassis is occupied by them. The main tuning condenser is rubber-

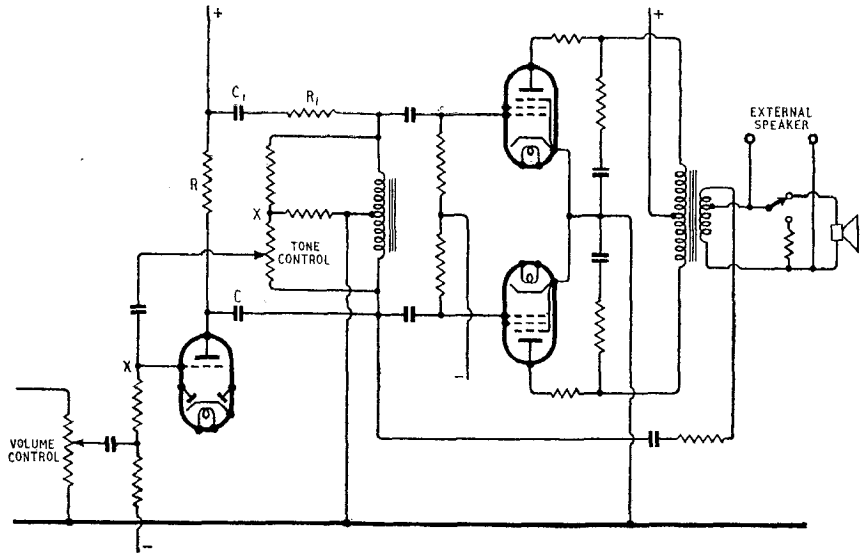

Fig. 3. Output stage and its associated circuits.

tions could be relied upon to find a wanted station.

Frequency stability was also very good and no warming-up drift could be detected. Station settings can be logged with accuracy by means of an auxiliary 180-degree scale.

The 8-inch loudspeaker gives good quality, and volume much above the average for a table model.

Mechanical Features. — The rather complicated wave-range switching is accomplished on three spindles, ganged together by a rack and pinion mechanism. It is positive in action and not unduly heavy to operate.

All trimmers are accessible from

mounted, but we did not find any evidence of microphony even when the condenser body was clamped for transit.

From every point of view the Type 681A can be classed as a high-quality receiver and it is particularly well fitted for serious short-wave listening.

The makers are Philips Electrical, Century House, Shaftesbury Avenue, London, W.C.2.

PUBLICATION DATE

In future *Wireless World* will be published on the last Thursday of the month preceding the date of publication instead of on the 26th as in the past.

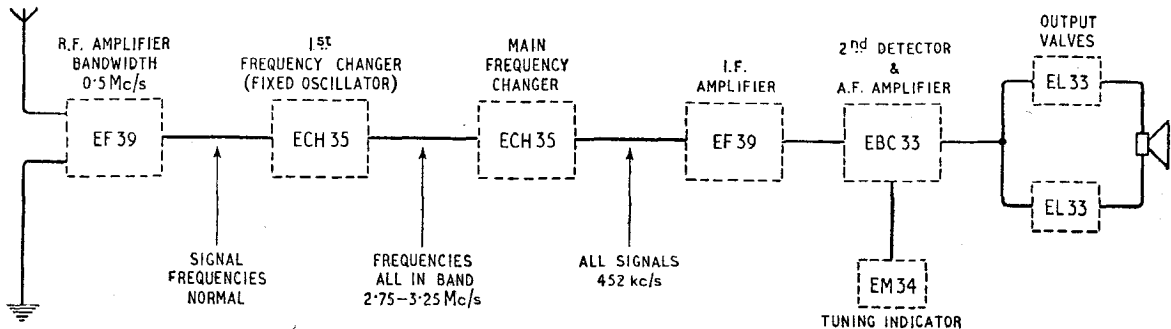

Fig. 2. Block diagram showing progress of signal on bandspread ranges

1R5

1SA

3SA

1S5

1TA

1L4

3VA

A POPULAR range of Brimar Battery Miniatures suitable for all Battery Receivers built since the war.

Reception Tested, for reliability, Brimar Miniature Valves are manufactured to a specification to entirely eliminate microphony.

BRIMAR

MINIATURE VALVES

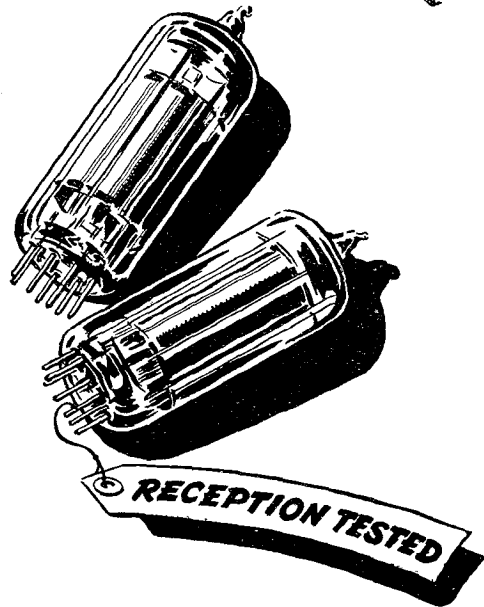

STANDARD TELEPHONES AND CABLES LIMITED, FOOTSCRAY, SIDCUP, KENT.

CRYSTAL PICK-UP PREJUDICES

—*their Rhyme and Reason . . .*

PREJUDICES are frequently unreasonable, often enough they are formed not from experience but from hearsay. The reputation of Crystal pick-ups has suffered in this way, yet every day and any day there are many thousands of Crystal pick-ups giving delight to gramophone enthusiasts, particularly those who are "sound purists." Then why this prejudice in other quarters? Let us be frank. *Under certain circumstances* Crystal pick-ups have in the past possessed some failings, but, let us hasten to add, failings small enough to be discounted by the user who sought the finest yet obtainable in sound reproduction.

Now, when Radiolympia is about to show us the great strides that ACOS research has made in utilising the amazing characteristics of the piezo-electric principle, it is opportune to review the reasons for the prejudices which persist from the pre-ACOS era.

The fallacy of their fragility

First, there is the belief that the Crystal pick-ups must necessarily be fragile and easily damaged. True, certain early types were easily fractured because assembly methods were as yet unperfected. But the Cosmocord laboratories produced an unbreakable crystal assembly which ensures that NO crystal in an ACOS pick-up can be broken, even by so drastic a measure as tapping the needle with a hammer—an extreme of violence which would never be approached in ordinary usage.

Humidity deterioration effects defeated

A second persistent prejudice against Crystal pick-ups is that the crystal element—Rochelle-Salt—is susceptible to deterioration when subjected to the higher degrees of humidity. Since this failing is an inherent characteristic of Rochelle-Salt, counter measures had necessarily to be those of *protection*. ACOS research was indeed set a formidable problem, the solution of which was particularly elusive, for in

this country the humidity count is much higher than, say, in the United States, where Crystal pick-ups are in almost universal use. Nevertheless the problem was solved by long and intensive research in the Cosmocord laboratories. Now an assembly has been designed which positively counteracts any danger of deterioration from humidity. In this assembly the crystal is mounted in a gel-like substance which provides a complete water-vapour barrier, rendering the cartridge absolutely non-hygroscopic.

Equaliser Circuits now past history

Another criticism is that the Crystal pick-up requires the fitting of an equaliser before satisfactory reproduction can be obtained from the ordinary commercial "constant velocity" records. In passing it should be mentioned that this condition is not confined to Crystal pick-ups only. The criticism is then that in order to attain the best from a crystal pick-up it is necessary to spend time and money on fitting additional components. The connoisseur of sound reproduction has con-

sidered this effort well justified by the results, knowing that a crystal pick-up alone is capable of giving him the high quality he demands.

Now, however, even the critical requirements of the connoisseur can be met without recourse to an equaliser circuit for again ACOS research has solved the problem in providing a crystal pick-up which, without additional components, can be connected direct to any domestic radio set or amplifier.

An invitation to the critics

Thus all past criticisms have been met, and any lingering prejudices shown to be without reason. And in confirmation there is to be inspected *and heard* at the Cosmocord Stand No. 7 and Demonstration Room No. D.10 the latest product from the Cosmocord Research laboratories—a Crystal pick-up of revolutionary design which, apart from providing a new and higher standard of performance, is also a thing of beauty. This pick-up will be available through the Trade after Radiolympia.

See and hear the new

ACOS G.P.20 MICRO-CELL PICK-UP at RADIOLYMPIA

STAND NO. 7. DEMONSTRATION ROOM D. 10.

- Has output 5 to 20 times greater than that of any comparable magnetic type.
- No equaliser components required. Can be connected direct to any domestic radio or amplifier.
- Has unbreakable Crystal element.
- Is unaffected by conditions of extreme humidity.
- No needle talk.
- Record wear virtually eliminated.
- Has provision for interchangeable clip-on head for long playing records. One instrument for ALL records.



COSMOCORD LIMITED • ENFIELD • MIDDLESEX

TELEVISION MOVING IMAGES

By

R. W. HALLOWS,

M.A., M.I.E.E.

Further Thoughts on Definition

IN the pages of *Wireless World** and elsewhere there has been much discussion of late concerning the many problems involved in television definition. The writers of the articles (I feel that I may be permitted to criticise, since I was one of them) like the participants in most verbal discussions and the authors of many textbooks, advance arguments that are perfectly sound, so long as one rather important proviso is made. That proviso is, perhaps, something more than rather important; for it is to the effect that in television transmission and reception we are mainly concerned with still images, such as test patterns. All of the generally accepted rules and equations are of unquestionable correctness when applied to still images; they enable one to calculate to a nicety the modulation bandwidth needed to deal properly with fixed vertical straight lines of any width and spacing, or the number of scanning lines necessary to televise fixed horizontal straight lines of any width or spacing.

Movement the Keynote

The contingency that they do not cover is that the lines in question should be moving. And movement is surely the keynote of television. The cinematograph could never have obtained its present popularity as a means of entertainment had it not been able to outdo its forerunner, the magic lantern, by projecting moving scenes on to the screen. Years ago the B.B.C. and the Vienna broadcasting station ran for some time transmissions of still pictures, which would be received in anyone's home by means of comparatively inexpensive apparatus fed by the output of an ordinary receiver. The pictures themselves were

excellent—as still pictures. It took about four minutes to receive one of them and those who came to one's home to witness the new miracle of broadcasting were lost in wonder and admiration: but, apart from their novelty-appeal (which soon wore off, as I can testify from personal experience, even with the most dyed-in-the-wool wireless enthusiasts) these transmissions had no genuine entertainment value. It was not until J. L. Baird showed that moving images could be transmitted and received by radio that broadcast pictures stood any real chance of providing worth-while entertainment in the home.

When we come to consider the moving image, as opposed to the still, test-pattern, new factors are involved; and these modify considerably the accepted ideas of definition in television.

Let us take as the basis of the argument a runner, human or equine, moving at such a velocity that his image would cross the screen of a television receiver in one second. I am not for one moment suggesting that the transit of the subject of a television broadcast from one side to the other of the viewing screen would ever occur in practice in this space of time. An important part of the technique of the operator of a television camera is to ensure that no such thing happens: by swinging his camera he keeps his principal subject at or near the centre of the screen at all times.

The reason for this is that the viewer instinctively keeps his eyes glued to the most arresting figure in the scene shown on his screen. So long as he can do this without moving his eyes, all is well; but if the figure is allowed by the camera operator to move rapidly across the screen and the eyes of the viewer follow its move-

ment, interlacing is at once destroyed and "interline flicker" is very much in evidence. This would not happen if the movement of the eyes was absolutely parallel with the scanning lines; but there is nearly always some vertical component in the passage of a figure across the screen.

Yet, no matter how great the skill of the cameraman parts of any rapidly moving image must have velocities such that, if they did move right across the viewing screen, they would do so in one second or less. Think, for example, of the legs and feet of a dancer or a runner, of the hands of an actor making a gesture, or of the whole outline of a figure which makes some brief, rapid movement too quickly for the camera to be swung so as to follow it. Things of that kind are constantly happening in every television transmission; it is in fact, to the continual occurrence of numbers of such movements that the television image owes its animation.

The Moving "Figure"

It is simplest to think of our object as a single vertical straight line, moving from left to right across the screen with a velocity that would accomplish one complete traverse in one second. This straight line we will call the "figure" for the word "line" is needed for other purposes. During the first odd-numbered 405-line interlaced scan one small element of the figure is depicted on the screen. This is a straight line equal in length to $1/377$ th of the height of the whole screen image, since 377 is the number of active lines. The next element is put in 99 μ sec later (99 μ sec is the total duration of a line, including initial and final blacks and line sync pulse) by the

*Television Standards, *Wireless World*, October, 1948; Television Goodness Factor, *ibid* March, 1949.

Televising Moving Images—

following odd-numbered line. In that time the figure has travelled a distance equal to 0.000099 of the whole width of the screen: the second element appearing on the viewing screen is therefore displaced by this distance from one before. As odd-numbered line follows odd-numbered line the displacement of the elements is cumulative. If we were watching a 10×8 -in image the displacement of the final odd-numbered element of a figure extending to the whole height of the screen would be $0.000099 \times 188.5 \times 10 =$ approx. 0.19 in.

The result is illustrated diagrammatically and in much exaggerated form in Fig. 1 (b). It must be emphasized that in the ordinary way the eye of the viewer is not actually conscious of any leaning of a moving figure. Still, the inclination is there and it must to some extent affect the reproduction of the image. It will be seen that the original vertical line of Fig. 1 (a) has become a slope built up of displaced vertical elements with gaps between them. Were the figure stationary, these gaps would be filled by the even-numbered scans. As the figure is moving the even-numbered elements do not fill the gaps. Since there are

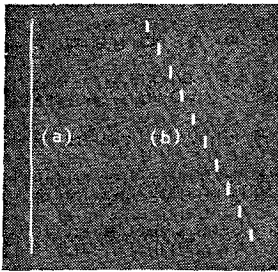

Fig. 1. Showing in much exaggerated form the elements "painted" by the odd-numbered lines in the reproduction of a moving vertical line.

50 frames per second, each including frame sync pulses as well as active lines, every even-numbered element is displaced by $1/50$ th of the screen-width, or $1/5$ th in. on a 10-in screen from its corresponding gap. This is illustrated, again with considerable exaggeration, in Fig. 2 (a). Fig.

2 (b) shows how the original clear, single, vertical line is reproduced as two slopes, each composed of spaced and displaced vertical elements. Besides the distortion introduced by the slope, there must be some haziness due (1) to the gaps between the elements and (2) to the fact that the elements are vertical whilst the line built up by them is not.

Several interesting facts emerge from these considerations. The first is that it becomes doubtful whether in the case of a moving image, we are entirely justified in regarding each even-numbered scan as complementing and, so to speak, belonging to the preceding odd-numbered scan, the two together forming one image complete in itself. An even-numbered frame would "belong" unquestionably to the preceding and not to the following odd frame, if there were a short blackout between an odd frame and the even frame following it and then a much longer blackout

after the even frame to mark the completion of the image. As it is, the sync pulse blackouts are identical in duration in both cases.

Consider the four consecutive frames seen in Fig. 3. Can it be held that A and B or C and D are always linked together to form images and that in some way the eye combines them rather than B and C? Is it not nearer the truth to regard A, B, C and D each as separate skeleton images, from the merging of which the eye receives a reasonably good general impression of a moving object rather than a clear-cut picture?

In any event it is plain that no increase in the number of scanning lines can make any improvement in the distortion due to the sloping reproduction of an image moving across the screen. This slope, or "distortion angle" becomes less as

the number of frames per second is increased. From this it becomes apparent that the use of a larger number of frames is likely to provide a better moving image and that the 60 frames per second used in the U.S.A. may, after all, mean something more than a mere waste of good bandwidth.

A second small shock comes when we think about those gaps between the elements in each frame of a moving image. More lines must lead to smaller gaps and, therefore, to a clearer picture drawn by each frame. A figure in vertical movement is, again, likely to be better reproduced by the use of a larger number of scanning lines. In fact, by taking

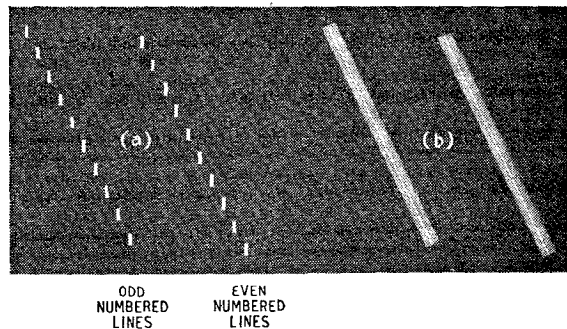

Fig. 2. The reproduction—again much exaggerated—of a single moving vertical line by two consecutive frames.

an extreme case and imagining the lines reduced to a very small number it is not difficult to picture a narrow horizontal figure in rapid upward or downward movement which is barely touched by any scanning line—or even not touched at all.

What it comes to is that calculations of balanced definition cannot be based entirely on the transmission and reception of still images. The moving image, which is what we want to televise, brings many new complications into the problem. Since we live on the surface of the ground the movements that we and our fellows most often make, and those which are, therefore, the most important to television, are in the horizontal sense. To attain genuine high-fidelity reproduction of these on the c.r.t. screen it is probably necessary to increase the number of frames to more than

50 per second. I have given some reasons why interlaced scanning cannot be looked to to furnish the answers we had hoped.

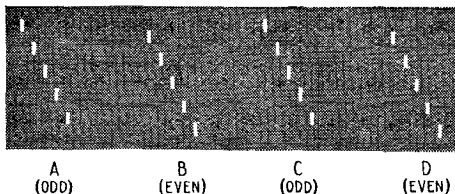

Fig. 3. Four consecutive frames reproducing a moving vertical straight line. Does A always interlace with B and C with D?

For what it is worth, my view is that research on high definition television should not take 1,000-line scanning as its goal. Rather, it should be directed first and foremost towards developing methods of producing wide-band transmitting and receiving gear

at reasonable cost. Once that has been accomplished, the next objective should be to discover how to make the best use of the bandwidth of, say, 20 Mc/s thus made available. It goes almost without saying that single-side-band methods of both transmission and reception will be used, which means that a modulation-frequency range of some 18-19 Mc/s will be possible.

The most important problem will then be to discover how best to use the frequencies available. Experiment will show what the eye will and will not accept. For moving images it appears to be important to strike the most suitable balance not so much between horizontal and vertical definition as between the number of images per second, and the number of scanning lines. My feeling is that we should

plump for sequential scanning. Where the best balance lies between image-frequency and number of lines only experiment can decide. It may be that it will be found with 50 images per second and some 700 lines. The ciné film to-day uses the equivalent of 72 images per second; there are actually 24 pictures projected each second, but two blackouts occur whilst each is on the screen and a third between it and the next picture. It may, then, be that the high-definition television of a few years hence will find that the best balance is obtained by combining an image-frequency of 75 per second with a small number of scanning lines.

But—and it is a big but—all that depends upon the discovery of a means of producing wide-band gear, and particularly receiving apparatus, at a cost considerably lower than that ruling at present.

MARINE SOUND EQUIPMENT

IN order to facilitate the demonstration of marine sound amplification systems, Ardenne Acoustic Laboratories have equipped a large caravan with the various types of apparatus produced for use on merchant ships. The unit is entirely self-contained and carries its own power supplies so that demonstrations can be given anywhere.

The towing vehicle is a complementary part of the unit, since it carries a special dynamo for battery charging. It also has a pair of weather-proof loudspeakers and a loud hailer on the roof.

Inside the caravan is a comprehensive display of Ardenne marine sound apparatus. One interesting item is the "Sonomarine" system giving radio, gramophone and speech facilities in all parts of the ship. It operates from the ship's mains of from 100 to 250 volts a.c. or d.c. It has three microphone input circuits, and these can be arranged in order of importance. Thus the captain would be given highest priority and, no matter what is being relayed, switching on his microphone immediately silences everything else. Every loudspeaker in the ship comes on at full volume even if it had been turned down or even turned off. An announcement from any microphone interrupts radio or gramophone in the same way.

Another piece of equipment we had demonstrated to us was the

"Talk-Back Hailer," a combined communication system having three sub-stations and a loud hailer. This is battery operated, 12 or 24 volts, and has a 4-valve amplifier, resistance-capacitance coupled throughout, with a small motor generator for h.t. supply.

At the sub-station the loudspeaker serves also as a microphone, and the sensitivity is such that replies from a considerable distance can be made if extraneous noises are not overriding. It has marked directional properties and this can usually be taken advantage of in mounting it. At a demonstration in the open and

with some traffic noise to contend with replies from distances up to about 20 feet were perfectly audible.

Among the other apparatus in the caravan is a "Master Communicator" which is a multiple system feeding up to 10 remote stations, all with "talk-back" and calling facilities. The loudspeaker is in all cases used as a microphone for replies. There are examples of the various styles of loudspeaker available for cabin or deck use, microphones and a small emergency communication set for point-to-point working, which does not use valve amplification.

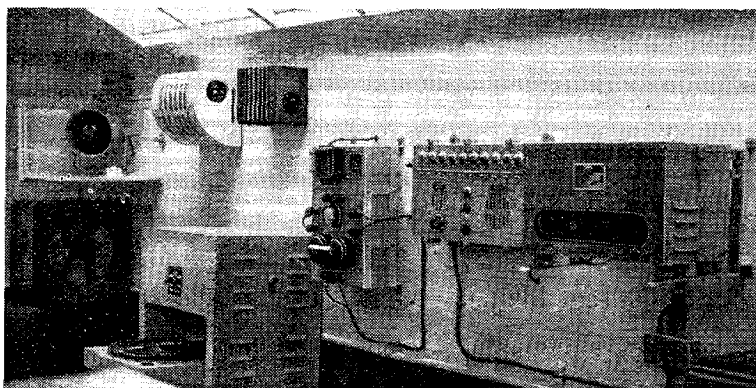

Part of the marine sound equipment inside the Ardenne mobile demonstration unit. Shown are the "Master Communicator," a loudspeaker mounted on a quadrant which swings outside when required and cabin-type loudspeakers.

AUDIO SIGNAL GENERATOR

Basic 20-20,000-c/s Oscillator with Optional Refinements

By **M. G. SCROGGIE, B.Sc., M.I.E.E.**

DETAILS of this instrument are offered in the hope that they may be of interest to readers who want to construct an oscillator covering the audio band. Some of the features are unusual and have been found very convenient for general laboratory work. In case a glance at the full circuit diagram (Fig. 1) and the control panel suggests that it would be better to look elsewhere for something simpler, it should be understood that most of the apparatus shown consists of optional "extras."

General Description.—The nucleus is a 2-valve resistance-capacitance oscillator (V1 and

harmonic distortion, is about 40 mW (20V peak across 5 kΩ) and is held constant by a thermistor within 0.2 db or less over the whole frequency range of 20 to 20,000 c/s, covered in three decade ranges.

The usefulness of the instrument, especially for measurements on amplifiers, filters, etc., is much increased by adding the attenuators, covering 0 to 105 db continuously by means of a 0.5 db potentiometer in front of the output stage and two switched attenuators following it, one giving four 5 db steps and the other four 20 db steps.

V6 and V7 comprise another

the effects of all stray capacitances from bridge arms to earth to be practically eliminated.

An incidental advantage of having the two output stages is that their signal currents cancel one another out in the anode supply circuit.

If steep-fronted square waves are available, apparatus under test can be much more searchingly examined than with sine waves alone, and many transient effects are shown up that would otherwise go unrevealed. So the next refinement is a squarer section (V3 and V4), brought in as desired by a Sine/Square change-over switch. The complete absence of signal transformers anywhere in the instrument, and the use of simple

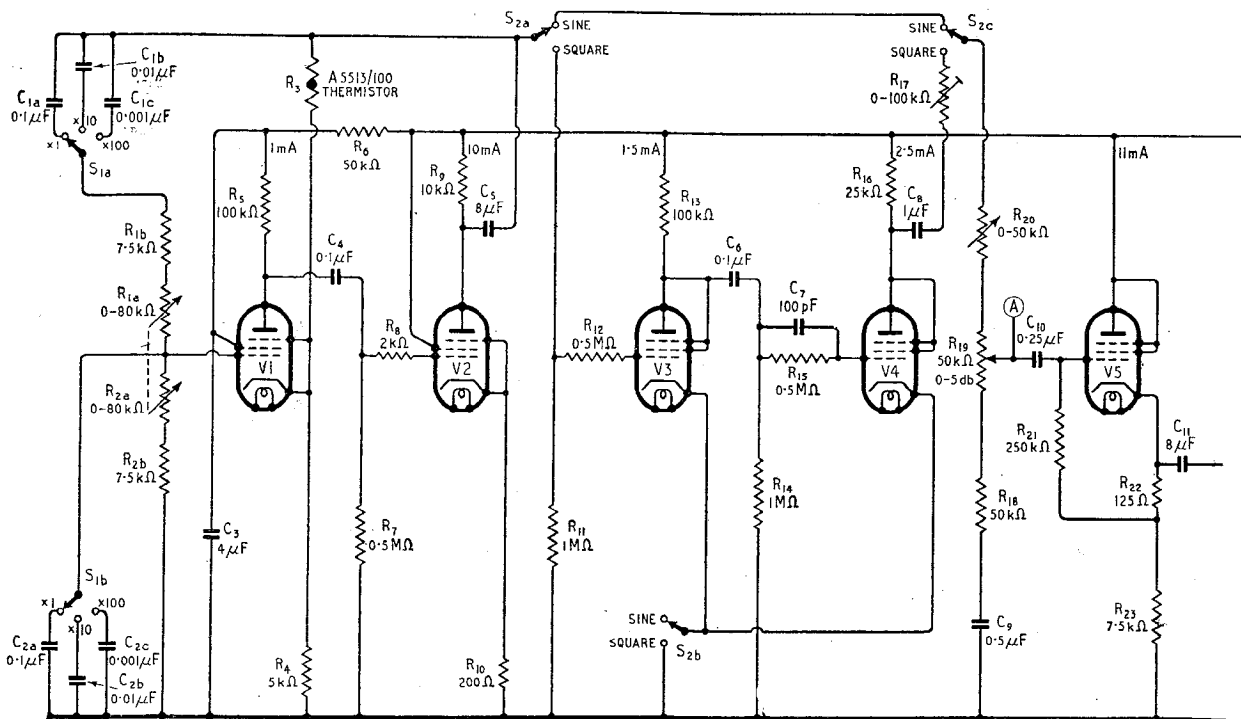

Fig. 1. Complete circuit diagram, with component values and approximate current readings

V2 in Fig. 1), which with one of the cathode-follower output stages (V5) would make a self-sufficient audio source. This circuit is shown by itself as Fig. 2.

The output, for less than 1%

refinement—a phase inverter and second output stage. For many purposes it is useful to have an output balanced to earth. In bridge work this feature is equivalent to a Wagner earth and enables

low-frequency compensation, assist in the preservation of good flat tops down to 20 c/s and wavefronts of only a few microseconds duration.

Lastly there is V8, a valve

voltmeter, with a switch to connect it to various points in the signal generator and also to an external terminal so that the voltmeter can be used independently. A simple device renders the calibration unaffected by the worst fluctuations in anode voltage.

A further provision that might be useful would be a switch to change the grid of V1 over to an external terminal, so that the instrument could be used as an amplifier, squarer, phase splitter, etc., for external signals.

The particular generator shown was adapted from a war surplus Test Set Type 87. In this way the whole of the chassis, mains power unit, all nine valves, much of their wiring, and many of the controls and components, were ready-made. The front panel was fairly easily removable for drilling holes to take the extra controls. The r.f. oscillator (the original set was a 150-300 Mc/s generator) was in a small section at one end and came away bodily to make room for the frequency-determining network.

Design Considerations — Oscillator.—The beat-frequency type

the ability to sweep over the whole frequency controls described in *Wireless World* by K. C. Johnson (March 1948) and B. J. Solley

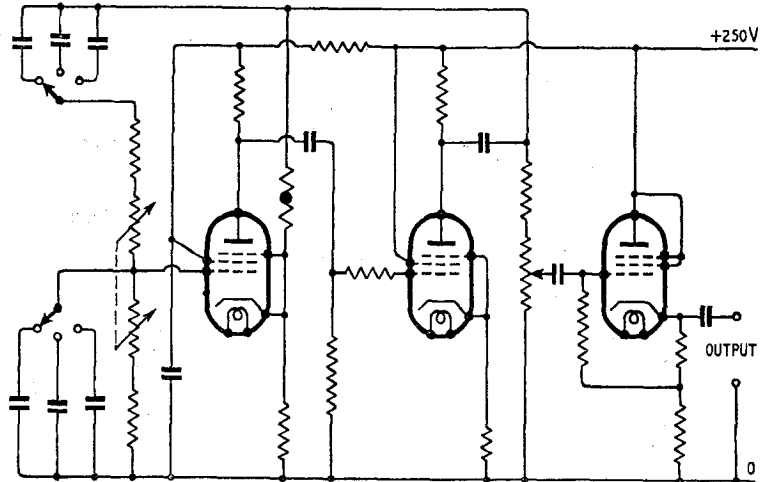
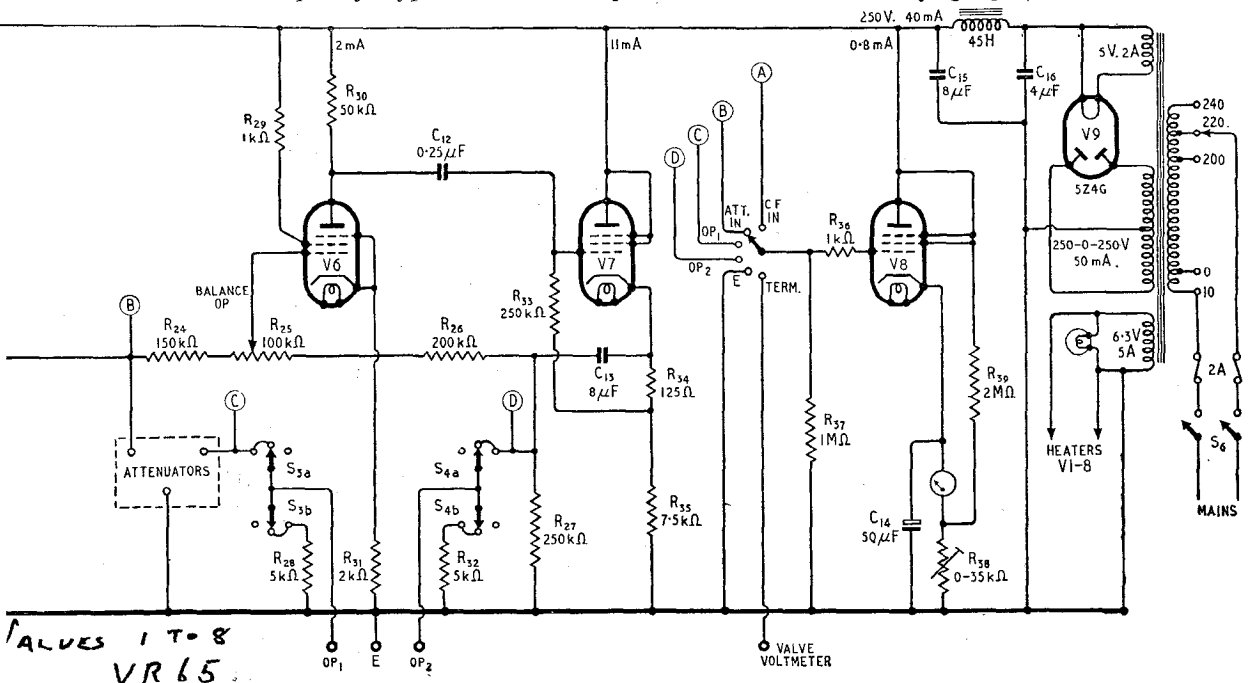

Fig. 2. Circuit diagram of the essential parts, consisting of bridge-controlled, amplitude-stabilized RC oscillator with cathode-follower output stage. Component values are as in Fig. 1.

the cramping of the frequency scale.

Before deciding on the conventional series-and-shunt or "Wien bridge" network, con-

(Sept. 1947). The latter was attractive not so much because the frequency is controlled by one potentiometer (after all, they are easily ganged) but because the



of oscillator was quickly ruled out because of the great difficulty of achieving stable frequency and pure waveform at the lowest frequency. Its one advantage—

siderable though) was given to possible alternatives. Twin-T networks were rejected as undesirably complicated. On the other hand there were the single-component

switching can be arranged so that three decades of frequency can be covered without a break, in three successive sweeps (up-down-up) of the control, and because a

Audio Signal Generator—

logarithmic scale is given by a linear potentiometer. But unfortunately the attenuation varies so widely with frequency setting that no automatic amplitude control could be found that would keep amplitude and waveform closely constant.

The theory of the Wien bridge oscillator is well known, but a recapitulation may be helpful. Neglecting R_3 and R_4 in Fig. 3, the two arms C_1R_1 and C_2R_2 form a potential divider such that the output (across C_2R_2) is in phase with the input (across the whole) at only one frequency, namely:

$$f = \frac{1}{2\pi\sqrt{R_1R_2C_1C_2}} \quad \dots (1)$$

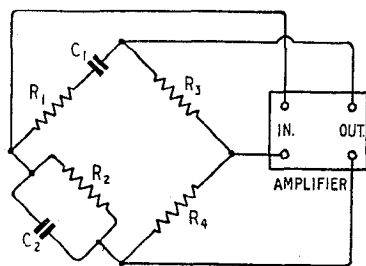

Fig. 3. Functional diagram of bridge-controlled RC oscillator.

When, as is usual, $R_1 = R_2$ ($= R$) and $C_1 = C_2$ ($= C$), this frequency is inversely proportional to R and C , and the output voltage is one third of the input (attenuation $9\frac{1}{2}$ db). If, therefore, this output is fed back to the input through an amplifier having $9\frac{1}{2}$ db gain and zero phase shift, continuous oscillation will be maintained at frequency f .

Any phase shift in the amplifier necessitates a corresponding phase shift in the RC network and consequently a departure from the frequency as given by equation (1). To minimize amplifier phase shift, and so stabilize the frequency of the oscillator, negative feedback is usually introduced, by feeding the input in opposite polarity with a proportion of the output, tapped off by the potential divider R_3R_4 . The gain of the amplifier must of course be correspondingly increased.

Another way of looking at the circuit is to consider it as a bridge, which would be balanced if $R_3 = 2R_4$, because both "detector" points would then be at the same

potential. In other words the attenuation of the network would be infinitely large. By lowering the tapping of R_3R_4 the attenuation is reduced, until the loop gain of the amplifier is sufficient to cause oscillation.

If the gain of the amplifier itself is made very much larger than $9\frac{1}{2}$ db the necessary shift in the R_3R_4 tapping is small, so that the $R_3:R_4$ ratio becomes extremely effective as an oscillation control. By choosing for R_3 an element whose resistance decreases with amplitude of oscillation (or R_4 with opposite characteristics), the amplitude is automatically limited other than by overloading of the amplifier and consequent distortion.

Using a bridge circuit, one inevitably encounters the difficulty that either both the input or both the output terminals must be at signal potential. There is the further difficulty in this case that for good a.a.c. (automatic amplitude control) the control element should not have to carry d.c. as well as the signal a.c. In some designs, R_3 and R_4 have been made respectively the anode and cathode resistors in the output stage: but since they must necessarily be fairly low in resistance, the exclusion of d.c. from the control element without bypassing most of the signal a.c. and introducing phase shift at

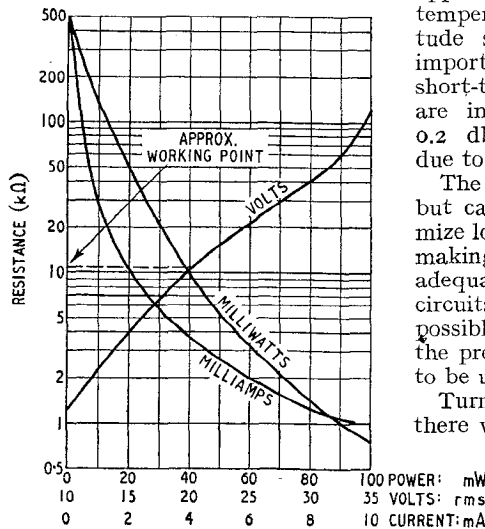

Fig. 4. Characteristics of Standard Telephones thermistor Type A5513/100 (R_3 in Fig. 1).

the lowest frequencies is an awkward requirement. In the present design the alternative has been

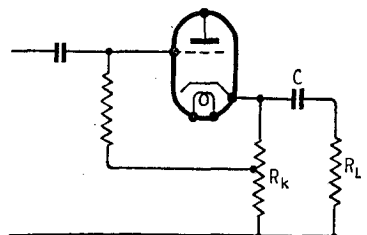

Fig. 5. Schematic circuit of output stage.

chosen, so that R_3 in Fig. 3 is the thermistor R_3 in Fig. 1, and R_4 is the cathode resistor of the input valve V_1 . The signal current in R_4 via V_1 is small compared with that from V_2 via R_3 .

Fig. 4 shows the characteristics of the thermistor, Standard Telephones Type A5513/100. This device is many times more effective than the special lamps that are usually specified for a.a.c., and at one stroke completely banished all the "hunting" (or amplitude bounce) troubles that had been experienced with lamp or rectifier methods of a.a.c. It occupies negligible space (approx. 1in long by $\frac{3}{8}$ in dia.), and is cheaper than special lamps: and it is obtainable in higher resistances, more suitable for valve circuits. It is appreciably sensitive to ambient temperature, but long-term amplitude stability is relatively unimportant. At the output of V_2 , short-term amplitude variations are imperceptible, most of the 0.2 db drop at 20,000 c/s being due to the coupling to V_5 .

The amplifier is conventional, but care must be taken to minimize low-frequency phase shift by making the coupling capacitances adequate in relation to the coupled circuits. Parasitic oscillation is possible with some layouts, and in the preliminary trials 100 pF had to be used across R_7 .

Turning to the frequency control there was the question of capacitance variation *versus* resistance variation. Most designers favour capacitance as the continuously-variable element, for the sake of smoothness of control. But even if two 4-gang capacitors are coupled together

ELECTRONIC CIRCUITRY

Selections from a Designer's Notebook

By J. McG. SOWERBY

(Cinema Television Ltd.)

LAST month ring counters were discussed, and it was shown how a counter of any division ratio consisting of the product of numbers not exceeding seven could be arranged. This month we shall discuss how a counter of any scaling factor may be designed starting with an appropriate chain of scale-of-two counters.¹

Electronic Counters (Concluded)

If we start with three scales of two in cascade, we shall have a total scaling factor of eight; and there will be eight possible different combinations of conducting (or non-conducting) valves in the three stages. We may give each of these combinations (or states) a letter, thus A, B, C, D, E, F, G, H, A, B, and the states will follow one another in the order given. Now if a scaling factor of seven is required, then we must arrange matters so that one of the states is missed—say A

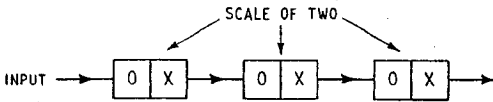

Fig. 1. Scale of eight in state A.

—so that the sequence of states becomes: B, C, D, E, F, G, H, (A), B, C, and the state which is missed is shown in brackets. Similarly to obtain a scaling factor of six the required sequence is C, D, E, F, G, H (A, B), C, D, and for five D, E, F, G, H, (A, B, C), D, E

If S is the number of states resulting naturally from a chain of a scale-of-two counters, S may have values of 2, 4, 8, 16, 32, 64, 128 If N is the required scaling factor then (S-N) states must be missed. To obtain a scaling factor of N=23 for example, one begins with a chain of scales-of-two having a natural scaling factor in excess of 23, by as small

a margin as possible—and in this case S=32. Then (S-N)=(32-23)=9 states must be missed. For illustration of the method we shall confine ourselves to S=8, as this is a sufficiently large number to indicate the principles involved, and in addition by arranging for three states to be missed a value of N=5 is obtained.² This is particularly valuable as a scale of five in association with another scale of two forms a scale of 10, or counter decade.

Fig. 2. Block diagrams, modified scale of eight.

As we have already discussed a scale of two, interest is now centred on the means whereby particular states in a chain of scales of two can be arranged to be missed. Let us first therefore draw up a table showing what combinations of conducting and non-conducting valves correspond to the eight possible states in the chain of three scales of two shown schematically in Figure 1. This shows three rectangles each of which is divided into two, so that each square corresponds to one valve in a scale of two. We may begin with all the left-hand valves conducting—indicated by (O) and all the right-hand ones non-conducting—indicated by (X). In drawing up the table we may confine our attention to the left-hand valves only, and indicate whether each one is conducting (O), or not (X). Thus:

TABLE.

		Three Scales of 2.										
		A	B	C	D	E	F	G	H	A	B	C
L.H.	1st Scale of 2 ...	O	X	O	X	O	X	O	X	O	X	O
L.H.	2nd Scale of 2 ...	O	O	X	X	O	O	X	X	O	O	X
L.H.	3rd Scale of 2 ...	O	O	O	O	X	X	X	X	O	O	O

There are eight possible states —A to H inclusive— after which the sequence repeats. On closer inspection we see that in the last scale of two (the third in this case) (X) changes into (O) only at one point in the sequence; in changing from states H to A, in fact.

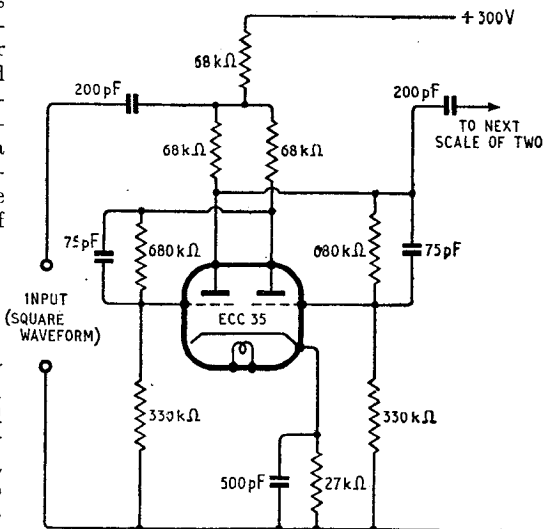

This is not true of any of the other scales of two, and means simply that one pulse of a particular polarity can be obtained from the last scale of two once at the completion of each sequence of eight states.

Now suppose that we wish to have a scaling factor of seven so that, as already noted, state A is to be missed; when the circuit falls into state A it must be automatically altered to B. States A and B differ only in the condition of the first scale of two, so that to alter A to B the first scale of two must be reversed. This reversal may be carried out by injecting the pulse (derived from the last scale of two in changing from H to A) into the first scale of two in

² I. E. Grosdorff, R.C.A. Review, Sept., 1946.

¹ Blume, R. J., Electronics, Feb., 1948.

such an asymmetrical manner as to make the left-hand valve non-conducting. If this is done we obtain the block diagram of Figure 2 (a).

Again if a scaling factor of six is required, two states—A and B—must be missed. As H changes into A a pulse is derived from the last scale of two, and this is used to change state A automatically into state C. Now A and C differ only in the condition of the second scale of two into which the feedback pulse must be introduced asymmetrically as shown in Figure 2 (b). As the first scale of two remains unaltered in this arrangement it follows—as might have been expected—that the scale of six is built up of the first scale of two and a scale of three formed by the last two scales of two when the feedback has been added. Thus in arranging a scale of six we have also derived a scale of three.

Similarly if a scale of five is required, three states—A, B, and C—must be missed, and to convert A into D both first and second scales of two required to be reversed. The pulse from the last scale of two is then fed asymmetrically into both the previous scales of two as shown in Figure

If we take the reduction of scaling factor a step further to obtain

pulse and this technique is of value in flexible circuits of variable scaling factor.

A delayed feedback pulse is required when N is equal to or less than $S/2$. In circuits of fixed scaling factor, the difficulty need never arise, as if $N \leq S/2$ one or more scales of two can simply be removed from the circuit.

A scale of five circuit incorporating the feedback described is shown in Figure 3, and here

Fig. 4. Practical scale of two for low frequencies.

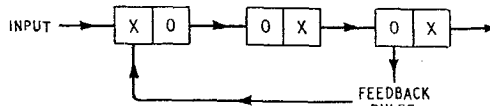

(a) SCALE OF SEVEN IN STATE F

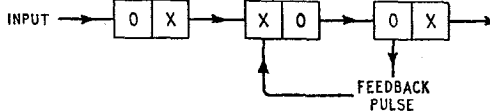

(b) SCALE OF SIX IN STATE C

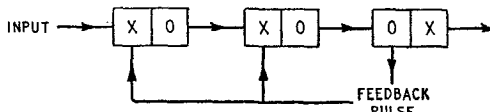

(c) SCALE OF FIVE IN STATE D

a scale of four a difficulty arises, as we shall then require states A, B, C and D to be missed, so that the sequence is E, F, G, H, E, F This requires that the third scale of two shall be reversed and since this reversal is caused by a pulse derived from the same scale of two, direct feedback of the pulse cannot be used, as the

each double triode and its associated components forms a scale of two. The feedback is applied asymmetrically at the grids of the first and second scales of two from one anode of the last scale of two.

For those readers who may wish for some initial guidance in experimental work, Figure 4 shows a practical scale of two, capable

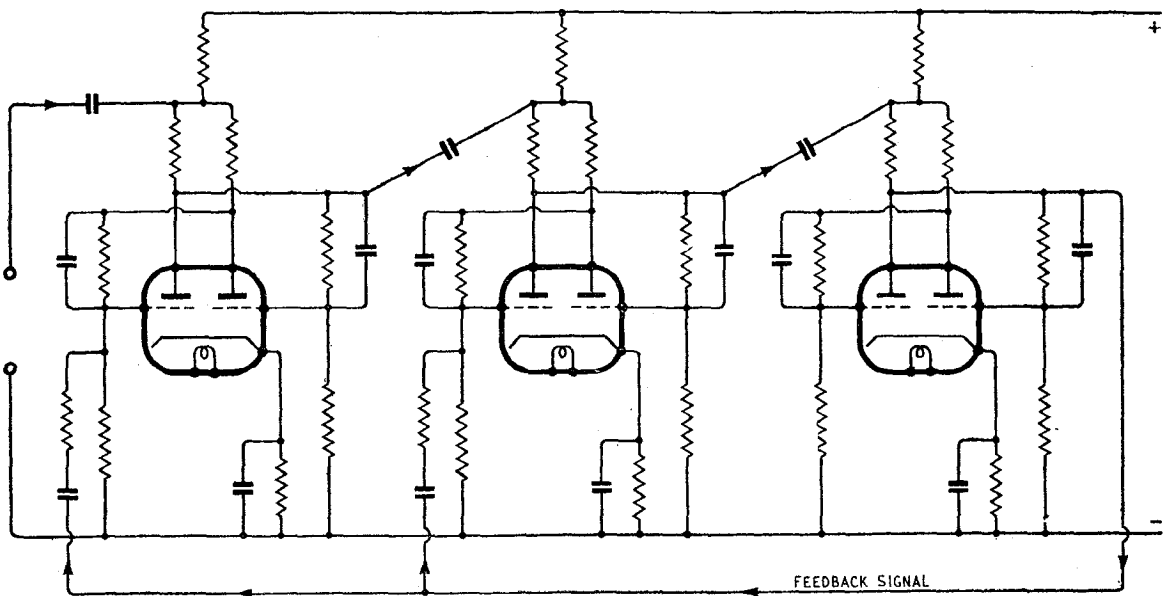

Fig. 3. Schematic circuit of scale of five.

2 (c). By prefacing this scale of five with another scale of two a counter decade is obtained.

pulse will then neatly cancel itself out. The difficulty can be overcome by delaying the feedback

of being cascaded without buffers, which is designed to operate at frequencies not exceeding 10 kc/s.

Electronic Circuitry—

In wiring care must be taken to keep stray capacitances to as low a value as possible, and it is desirable to wire the anode-grid coupling components directly across the valveholder. Matched pairs of resistances should be used where

Fig. 5. Circuit arrangement for frequency measurement.

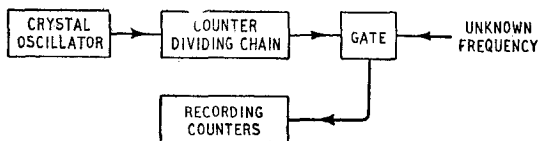

symmetry is desirable—i.e., in the anode loads and the cross-coupling networks. High stability resistors should be used for maximum reliability.

Having designed a counter of a particular scaling factor, one state is then allotted the figure nought, and then subsequent states are allotted numbers 1, 2, 3, 4 up to the scaling factor. It is usually convenient to be able to reset the circuit to nought, and this may be done by arranging for the valves to be forced into the state corresponding to nought either by applying a positive bias to those grids of valves required to be conducting, or by applying negative bias to those required to be cut-off. The bias may be applied on the depression of a push-button switch.

It is often desirable that the state existing in the circuit at any instant shall be indicated. The simplest and most usual way of arranging this is to associate a miniature neon indicating lamp with each scale of two to show which valve is conducting. Alternative methods of indication using milliammeters and cathode ray tubes are sometimes used.

The applications of counters

are many and various. One which may be of interest to readers is shown in Figure 5. This represents an arrangement for the accurate measurement of frequency. The reference standard is a crystal oscillator which is frequency

divided by a counter chain to produce pulses at 1 c/s. These are fed into an electronic gate which remains in its "open" condition for exactly one second. During that second the recording counters

are allowed to count individual cycles of the unknown frequency, so that at the conclusion of the second the unknown frequency is displayed on the indicators associated with the recording counters. The gate may be designed so that having once remained "open" for one second and closed again, it remains closed until reset manually. By this means the unknown frequency can be sampled for one second and the result displayed until reset manually. The method is limited to frequencies not exceeding the maximum repetition rate of the recording counters (about 1 Mc/s with present techniques), but within these limitations the method is extremely rapid and convenient.

MANUFACTURERS' LITERATURE

CATALOGUE of aluminium and aluminium-alloy wire from the Aluminium Wire & Cable Co., Ltd., 10, Buckingham Place, London, W.1.

Illustrated leaflets describing the Baird a.c./d.c. portable television receiver and the Scophony-Baird magnetic tape sound recorder for use with sub-standard film projectors, from Scophony-Baird, Ltd., Lancelot Road, Wembley.

Information leaflets (Nos. 1 to 4) dealing with neon test prod, appliance switches, fuses and plug-in ignition interference suppressors from A. F. Bulgin, Bye Pass Road, Barking, Essex.

Leaflet describing the Model 8903 record player unit, from the Marconi-Phone Co., Hayes, Middlesex.

Comprehensive catalogue of "Somerset" chokes and transformers, from Gardners Radio, Somersford, Christchurch, Hants.

Catalogue of television receivers for 1949-50 season from the General Electric Co., Magnet House, Kingsway, London, W.C.2.

Leaflet describing the Axiom 22, twin diaphragm, 20-watt loudspeaker and H6, 30-watt output transformer, from Goodmans Industries, Lancelot Road, Wembley.

Catalogue and price list of electrical meters from Taylor Electrical Instruments, 419-424, Montrose Avenue, Slough, Bucks.

The following new illustrated lists have been received from Marconi's Wireless Telegraph Co., Chelmsford: SL14/2, d.f. equipment; SL17/3, 500W transmitters; SP5, v.h.f. communication equipment; SP14, television equipment; DR9, type UR9 valve; SP7/3, transmitting and power rectifying valves; SP8/3, receiving and rectifying valves.

"Television Aerials," a booklet on choice of types and methods of installation, from Philips Electrical, Century House, Shaftesbury Avenue, London, W.C.2. Also leaflets describing Philips 25-W and 50-W amplifiers; type 98r6T 6-W horn loudspeaker; and "Voxmobile" p.a. equipment.

Brochure dealing with fabricated-plate electrolytic capacitors made by the Plessey Co., Components Division, Ilford, Essex.

Catalogue V-549 of "Variac" auto-transformers from Claude Lyons, 180, Tottenham Court Road, London, W.1.

Illustrated leaflet describing "Telrad" high-quality radio-gramophone, from Telrad Electronics, 70, Church Road, Upper Norwood, London, S.E.19.

Specification and technical details of Model RAxor schools broadcasting equipment, from Trix Electrical Co., 1-5, Marble Place, Tottenham Court Road, London, W.1.

List of d.c.-a.c. vibratory converters from Valradio, Ltd., 57, Fortess Road, Kentish Town, London, N.W.3.

Catalogue, with long technical introduction, entitled "Electrical Standards for Research and Industry" from H. W. Sullivan, Ltd., Lee Street, Peckham, London, S.E.15. For limited circulation only.

Catalogue of electrical, radio and television components from Mullard Electronic Products, Century House, Shaftesbury Avenue, London, W.C.2.

Leaflet describing "Eta" Series II permeability-trimmed i.f. transformers from Electro Technical Assemblies, 109, West Hill, St. Leonards-on-Sea.

"Report, 1948-49": financial report and illustrated record of achievements of the company for the year from Pye, Ltd., Cambridge.

MORE COPIES OF "WIRELESS WORLD"

As already announced, the Government's decision to increase the allowance of paper for technical periodicals makes it possible to print more copies of *Wireless World*. Starting with this issue there should be enough for all anticipated requirements. But the number of copies will still be limited, and so it will be necessary for an order to be placed with a newsagent.

THE "BELLING-LEE" PAGE

Providing technical information, service and advice in relation to our products and the suppression of electrical interference

Lightning Protection

At this time of year we constantly receive anxious enquiries as to the risk involved in having a television dipole* or "Skyrod"*2 aerial on the roof. We have not the slightest hesitation in stating that the chances of trouble are negligible.

Any "Belling-Lee" aerial, or radio or television receiver connected thereto is insured for the sum of £100 against damage by lightning. This applies in the event of there being no collateral insurance or after existing cover has been exhausted. This operates for one year after the date of purchase by the ultimate user no matter where purchased or by whom installed. If insurance companies considered aerials a risk, they would not be slow in calling for increased premiums.

We have been making and installing television aerials since the advent of television and of the total of all makes installed a very high proportion are of "Belling-Lee" manufacture, but we have no record of a single claim of damage by lightning, and we do not suggest that other makes of aerials are more likely to be struck. As things are at present we feel quite safe in suggesting that there must be more dwellings without aerials struck by lightning than vice-versa, but only because there are a greater number of such dwellings.

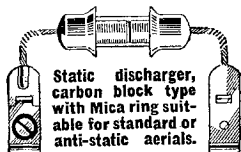

Manufactured by BELLING & LEE Ltd.
List No. L.350 selling at 9/6d.

Now Let Us Deal With Television Aerials*

It is almost impossible to envisage conditions which would set up an excessive potential difference between the two elements of a television

dipole, and consequently we need only concern ourselves with voltages which may develop between the dipole elements and earth. In some cases, where an unbalanced feeder is employed, one dipole element is connected to the earth, via the receiver, and there is no reason why the earthy conductor of the feeder should not be independently connected to a safety earth outside the building. This, however, would not really afford any advantage, since the unearthed element, which is usually the upper one, requires some other form of protection.

Obviously, any method of protection must take the form of a path to earth which only becomes operative when the potential of the conductor to be protected rises above a certain value. This points to some form of spark-gap. In a Television aerial a built up charge would spark across the dipole insulator, and it is only necessary to earth the cross-arm

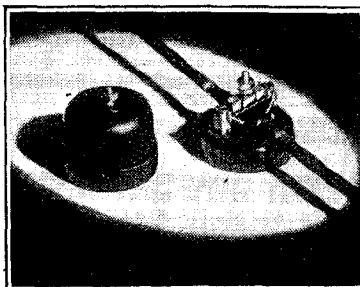

Another type of static discharger specially designed for use with Television aerials and "Belling-Lee" Twin-Feeder *3. List No. L376. Price 7/6d.

of the aerial in order to implement this form of protection. In theory, this method should be of greater value than a spark-gap placed in the feeder at, say, the point of entry into the house, since in such an arrangement the heavy discharge currents would have to flow through the conductors of the feeder, and might thus cause them to fuse. Smaller charges would leak to earth harmlessly in the cable.

In a normal installation we do not earth a crossarm or metal pole directly, because it all puts up the

Will those in coastal towns, fishing ports, yachting centres etc., bear in mind that "Belling-Lee" are specialising in suppression on board ship. We have done such work on ships of all sizes from the "Queen" class to trawlers, drifters and yachts.

cost of an already relatively expensive installation, and we do not consider the risk warrants even the extra few shillings. Instead we insure them all for £100. But, as mentioned above, where it is necessary to calm down an over anxious user, or in order to comply with a particularly fussy specification, the crossarm and/or metal pole may be earthed independently, with a copper conductor going to solid earth by the most direct route, and not round corners, nor entering the building.

If this conductor is as heavy as some authorities would like, its cost will be many times that of the most expensive television aerial installation.

- *1. "Viewrod" (Regd. trade mark) television aerial "H" type for chimney mounting L502/L London, £6/6/-. L652/LM Midland, £6/5/-. Simple dipole for chimney mounting L501/L London, £3/12/6. L647/L Midland, £3/5/-. "Veerod" (Regn. applied for) Inverted "V" television aerial chimney mounting L606 London, £4/10/-. L635 Midland, £4/2/6.
- *2. "Skyrod" (Regd. trade mark) 18 foot vertical aerials L638 collector, chimney mounting, £4/4/-. L638/K plus "Eliminoise" equipment, £10/-/-. L638/C collector mast mounting, £3/-/-. L638/CK plus "Eliminoise" equipment £8/15/-.
- *3. Balanced twin feeder. L336 un-screened 7½d. per yard. L1221 screened 1/9d. per yard.

BELLING & LEE LTD
CAMBRIDGE ARTERIAL RD., ENFIELD, MIDD., ENGLAND

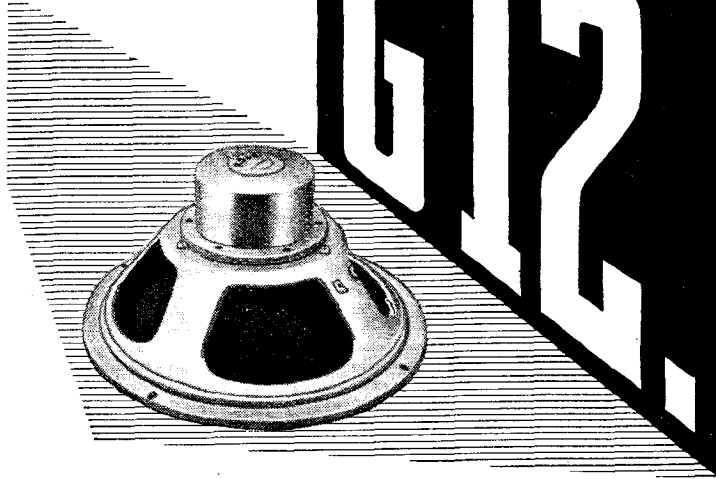
ROLA

Maximum sensitivity with uniform frequency response from a more compact speaker, appreciably reduced in weight—that is what Rola technicians have achieved with the new G.12. Special features include dust-proof suspension completely protecting coil and magnet gap and the powerful Alcomax II magnet. Write for details and also for particulars of Rola 3" and 4" P.M. models, dust-proofed and equipped with Alcomax II magnets.

**best
of the
BIG
speakers**

BRITISH ROLA LTD. · FERRY WORKS · SUMMER ROAD · THAMES DITTON · SURREY
Telephone : EMBERBROOK 3402 (5 lines)

"THE DX PLUS ONE FEEDER UNITS AND THE DX PLUS SEVEN QUALITY CHASSIS"

by the Specialists for Feeder Units and Chassis since 1934

Sound Sales Limited

PRICE
£15
plus P.T.

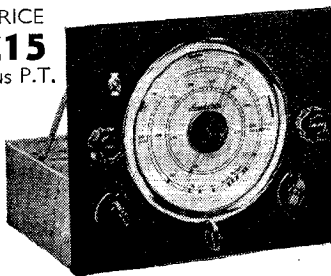

Remember that the products of **SOUND SALES LTD.**, are guaranteed for 12 months, in accordance with the guarantee issued.

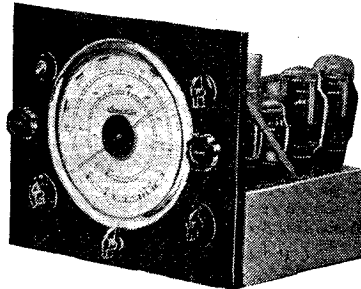

PRICE
£25
plus P.T.

Like the Phase Inverter Speaker, flattered by imitation, the Feeder Units and Chassis by Sound Sales Ltd., can usually be found as the Heart of most Quality Equipment.

Unique features include, the latest dial of no less than 8½ in. diameter, and tandem coupled variable selectivity, etc.

Particulars and Demonstrations from our London Office at

57 ST. MARTIN'S LANE, LONDON, W.C.2. TEMple Bar 4284

Works : West Street, Farnham, Surrey. Farnham 6461-2-3

WORLD OF WIRELESS

B.B.C. Inquiry ♦ Television Progress ♦ U.S.

Citizens' Radio ♦ New B.B.C. Station

Broadcasting Committee

THE committee set up by the Government to consider the constitution, control, finance, etc., of the broadcasting service in this country has been officially called the Broadcasting Committee, 1949.

The first meeting of the committee was held on June 24th under its new chairman, Lord Beveridge. It has been officially stated that the committee will be glad to receive representations from organizations and individuals on matters falling within its terms of reference. These should be sent to the Secretary, Broadcasting Committee, G.P.O. Headquarters, London, E.C.1, not later than October 1st.

Midland Television

TEST transmissions from a mobile transmitter set up in three centres within the area to be served by the Sutton Coldfield station, are to be radiated for the next two months in order to give dealers an opportunity of testing receivers.

The transmitter will operate for two or three weeks from a site in Birmingham and will then go on to

Wolverhampton and Coventry. A still image will be transmitted on the vision frequency to be used by Sutton Coldfield (61.75 Mc/s) with a power of about 1 kW. The transmissions should have a range of a little more than five miles. One of the B.B.C. O.B. transmitters with a "fire escape" aerial will be used for these tests, which will begin about the middle of August and continue until just before the Sutton Coldfield station opens—probably in November.

Third Television Station

ALTHOUGH official confirmation has not yet been given to the rumour that the B.B.C.'s third television station will be at Holme Moss, near Huddersfield, it is known that it is the chosen site so far as the B.B.C. is concerned.

Tests were carried out by B.B.C. engineers some months ago at a number of sites in the north-east, and the final choice was Holme Moss. Approval has, however, still to be received from various Government departments.

Some idea of the anticipated service area to be provided by the

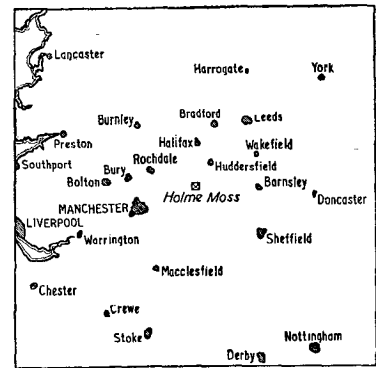

NORTH - EAST TELEVISION—
All the towns shown on this map are expected to come within the service area of the proposed television transmitter at Holme Moss.

station can be gained from our sketch map. Holme Moss, which is 1,750 feet above sea level, is on the borders of Cheshire and Yorkshire. With the introduction of this third transmitter it is anticipated that the country's potential television audience will be about ten million.

Communication Networks

THE problems arising in communication networks which utilize more than one method of transmission are most acute at those places where the different methods join up. Radio-telephone terminal units produced by the Marconi Company, in collaboration with Siemens Brothers, have been designed to minimize the special problems of linking radio and land-line transmissions. They ensure stability of signal and provide facilities for controlling the signal level, for discriminating against line and radio noises and for rendering conversation unintelligible to unauthorized listeners.

Twenty-two of these units, which embody the most recent circuit designs and practice of the G.P.O., have been ordered by Cable and Wireless. They can be remotely controlled and a number of terminals can be handled simultaneously from a central control.

Citizens' Radio

REGULATIONS were recently introduced by the F.C.C. for the licensing of citizens' radio stations as an established service. They have, up to now, been operating as experimental transmitters.

Under the new rules, any American citizen of 18 years of age or over may obtain a five-year licence to operate a station in the

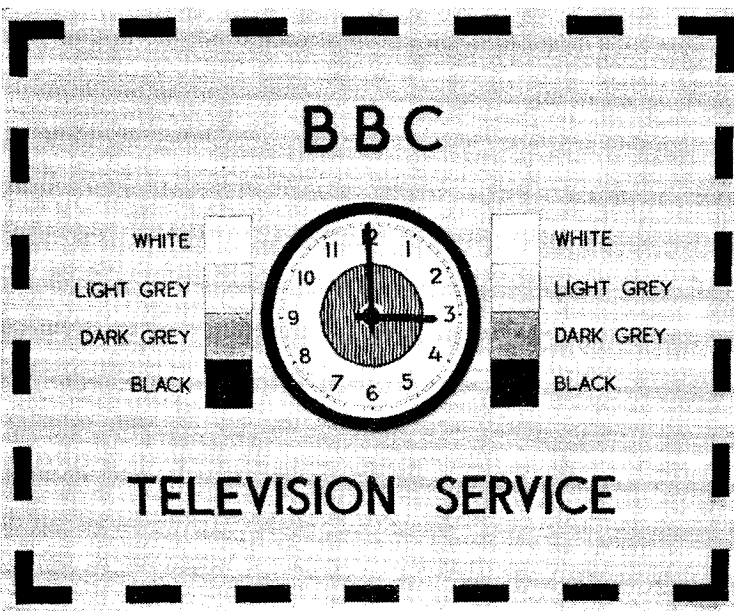

TELEVISION TUNING SIGNAL—This visual tuning signal is now being radiated by the B.B.C. prior to each programme. The monotone tuning note has been replaced by a specially composed tune.

World of Wireless—

460 to 470 Mc/s band. Two types of station, with powers of 10 and 50 watts, are authorized. Operation is limited to 'phone unless the licensee also holds a telegraphy licence.

The operation of "citizens' radio" differs from our "business radio" in that in this country one of the stations must be mobile. Moreover, there does not appear to be any provision to limit its use to purely business concerns—it is for "Sam Citizen."

East Anglian Transmitter

THE new B.B.C. station at Postwick Grange, near Norwich, which was opened last month, has an interesting aerial system. Two 126ft tubular steel mast radiators, spaced 240 feet apart, which is $\frac{1}{4}\lambda$ at the operating frequency of 1,013 kc/s, are used. The easterly mast is energized, the power being conveyed to it over a 6-wire feeder, whilst the other mast, which is not energized, acts as a parasitic reflector. Each mast is insulated from the ground and is connected to its nearby tuning house.

Between the mast heads are stretched two parallel wires, the end sections of which act as capacity tops and increase slightly the electrical lengths of the masts.

The present power of the new transmitter is 5 kW. Under the Copenhagen Plan it is permitted to use 20 kW.

European Broadcasting

ACCORDING to the latest survey of the International Broadcasting Organization, 195 frequencies between 150 and 1,600 kc/s were occupied by broadcasting stations at the beginning of this year. Some of these frequencies are used by as many as seven countries.

A chart published in the *O.I.R. Bulletin* shows that there were at that date 331 utilizations—that is, the use of a frequency by a country whether for one station, synchronized network or a number of low-power transmitters. The total is no less than that recorded six months earlier. The number of actual stations operating in this band is said to be approximately 426.

Colonial Broadcasting

ONE million pounds has been earmarked for the development of Colonial broadcasting services from the funds provided under the Colonial Development and Welfare Act. This was stated in the House of Commons in response to a question on the extension of the broadcasting systems in the Colonies.

It was further stated that a complete survey of the broadcasting needs of the four West African Colonies has just been completed; a wire rediffusion service designed to serve 10,000 homes has been opened in Hong Kong and that a detailed broadcasting system for Cyprus has also been prepared. The Northern Rhodesian Government is installing a higher-powered transmitter, and some thousands of cheap receivers, specially designed by a British manufacturer, were being made available to African listeners.

Slow Morse

THE latest schedule of slow morse transmissions radiated regularly by members of the R.S.G.B. and organized by C. H. L. Edwards (G8TL) is given below. The times are B.S.T.

Sundays

09.50 1840 kc/s G6NA (Guildford).
20.30 1802 kc/s G2DLJ (Derby).

Mondays

13.00 1870 kc/s G3AXN (Southend-on-Sea).
20.00 1900 kc/s G2AJU (Stutton, Ipswich).
20.00 1820 kc/s G3BHS (Eastleigh, Hants).
20.00 1800 kc/s G2DJS (Bradford).
20.00 1750 kc/s G3DSR (Derby).
21.00 1900 kc/s G2BLN (Bournemouth).
21.00 1850 kc/s G8VR (London, S.E.2).

Tuesdays

13.00 1870 kc/s G3AXN (Southend-on-Sea).
22.00 1896 kc/s G8TL (Ilford).
22.30 1896 kc/s G4GA (Chingford).
22.30 1820 kc/s G6JB (Salcombe, Devon).
23.00 1820 kc/s GMAAN (Kirkcaldy).

Wednesdays

20.00 3625 kc/s PA0AA (Hilversum, Holland).
20.00 1783 kc/s G3AFD (Southampton).
22.00 1800 kc/s G3DLC (Grays).
22.00 1840 kc/s G6NA (Guildford).

Thursdays

13.00 1870 kc/s G3AXN (Southend-on-Sea).
22.00 1873 kc/s G2BCX (South Woodford).
22.30 1873 kc/s G3ARU (South Woodford).
22.30 1803 kc/s G30B (Manchester).

Fridays

13.00 1870 kc/s G3AXN (Southend-on-Sea).
19.00 1900 kc/s G3BLN (Bournemouth).
20.00 1900 kc/s G2AJU (Stutton, Ipswich).
20.00 1820 kc/s G3BHS (Eastleigh, Hants).
20.00 1860 kc/s G3AKW (Wirral).
20.30 1868 kc/s G8LZ (Gravesend).
22.30 1820 kc/s G6JB (Salcombe, Devon).
23.00 1820 kc/s GMAAN (Kirkcaldy).

Saturdays

23.00 1800 kc/s G3CHY (Ashton-u.-Lyne).

OBITUARY

It is with regret that we record the death of **C. B. De Soto**, technical editor of the *Proceedings of the I.R.E.* and former editor of *OST*, at the age of 37. He was for sixteen years on the headquarters staff of the American Radio Relay League prior to accepting the editorship of the *Proc.I.R.E.* in 1945.

We also record with regret the sudden death of **J. A. Corbett**, the secretary of the Guild of Radio Service Engineers. He has been associated with the Guild from its earliest days.

René Mesny, professor at l'Ecole Supérieure d'Electricité of France,

who died on June 8th, was one of the pioneers of French radio, having been a close collaborator with General Ferrié. He was a specialist in direction-finding and author of many published works on fundamental research.

PERSONALITIES

Professor E. B. Moullin, M.A., Sc.D., professor of electrical engineering at Cambridge University, has been elected president of the I.E.E. for the ensuing year. He was chairman of the Radio Section for 1939-1940. Professor Moullin was lecturer at Cambridge from 1920 to 1929, during which time he established the electrical laboratory. His researches include work on radio-frequency measurements, dielectric losses and background noise in radio receivers.

Professor Willis Jackson, D.Sc., D.Phil., who has been head of the Electrical Engineering Department of the Imperial College of Science since 1946, has been elected a member of the I.E.E. Council. For eight years prior to going to the Imperial College he occupied the chair of electro-technics at Manchester University. He is a member of the Ministry of Supply Advisory Council on Scientific Research and Technical Development and of the B.B.C. Scientific Advisory Committee.

J. A. Saxton, Ph.D., B.Sc., A.R.C.S., who is in the Radio Division of the N.P.L., has been elected to the I.E.E. Council. Prior to going to the N.P.L. in 1938 Dr. Saxton was on the staff of the Physics Department at the Imperial College of Science. During the war he was Radio Liaison Officer at the British Commonwealth Scientific Office in Washington. His researches include investigations into the propagation of v.h.f. and the dielectric properties of liquids at microwaves.



PROF. E. B. MOULLIN, new I.E.E. President.

Sir George Nelson, chairman of the Marconi Group of Companies, has been elected a member of the I.E.E. Council.

Dr. E. C. Bullard, M.A., F.R.S., Professor of Physics in Toronto University, has been appointed director of the National Physical Laboratory in succession to Sir Charles Darwin,

K.B.E., Sc. D., F.R.S. During the war Prof. Bullard was concerned with the degaussing of ships against the magnetic mine and with measures to combat the acoustic mine. From 1944 to 1945 he was Assistant Director of Naval Operations at the Admiralty. He went to Toronto in 1948.

H. G. Whiting, who has been appointed engineer-in-charge of the Sutton Coldfield television station, joined the B.B.C. in 1932. He was for a short time at the Chelmsford experimental Empire station (G5SW) and then went



H. G. WHITING, Midland Television E.-in-C.

to the Daventry short-wave station. When the B.B.C. television service started in 1936 he transferred to Alexandra Palace. After serving at one of the overseas transmitters during the war he returned to A.P. as senior service maintenance engineer (studios). Before joining the B.B.C. he was with Western Electric (now S.T.C.) from 1921.

E. M. Deloraine, a director and vice-chairman of Standard Telecommunication Laboratories—the research organization of Standard Telephones and Cables—at Enfield, has received the degree of Doctor of Engineering from the University of Paris. He joined the London staff of Western Electric (now S.T.C.) in 1921 and became European technical director of the company in 1933.

W. J. Gray has retired from the post of assistant general manager of the Canadian Marconi Company which he joined in 1906. Prior to going to Canada he was six years with the G.P.O. and two years with the Marconi International Marine Communication Co. He was officer-in-charge at the Cape Race station in April 1912 and handled the messages from the sinking *Titanic*.

Dr. V. K. Zworykin, vice-president and technical consultant of the Radio Corporation of America, has been awarded the Lamme Medal by the American I.E.E. for his work on fundamental television and electronic apparatus.

Oswald F. Mingay editor and publisher of the Australian journal *Radio Electrical Weekly*, who was organizing secretary of the World Radio Conven-

tion, Sydney, 1938, is now in this country. Mr. Mingay, who is studying technical developments in all branches of radio, is on a 12-months' tour of Europe and America.

D. A. Lyons, managing director of the Trix Electrical Co., is examining the latest trends and production techniques in the American radio industry during a six-week's visit.

A. J. E. Hoyten has been appointed manager of the Bristol branch of the Edison Swan Electric Company at 47 Colston Street. He has been with the company since 1929 and has been in charge of the radio division's maintenance sales at the company's head office since the war. **G. W. Natrass** has been appointed manager of the Newcastle branch and **A. H. Sutton** manager of the Manchester branch.

IN BRIEF

11,873,950 broadcast receiving licences, including 140,850 for television sets, were current in Great Britain and Northern Ireland at the end of May. The month's increases were 43,350 "sound" licences and 7,600 for television.

I.E.E. Radio Section.—No nominations other than those made by the Section Committee having been received to fill the vacancies occurring on the committee on September 30th, the following were duly elected:—chairman, R. T. B. Wynn, assistant chief engineer, B.B.C.; vice-chairman, Dr. D. C. Espley, G.E.C. Research Laboratories; A. W. Cole, Marconi's; Dr. H. G. Hopkins, D.S.I.R.; Dr. J. S. McPetrie, S.K.D.E.; Dr. R. A. Smith, T.R.E.; and H. Stanesby, P.O. Research Station.

I.E.E. Students.—The new vice-chairman of the committee of the I.E.E. London Students' Section is I. J. Shelley, of the B.B.C.



OSWALD F. MINGAY
(See Personalities).

Record Processing.—For the guidance of those who may wish to have pressings made from direct disc recordings, the Association of Professional Recording Studios has issued a pamphlet setting out the requirements of a good recording from the point of view of those who will have to process the

record and make the stamper. The author is E. B. Pinniger, F.C.S., and the title is "Recording Discs for Processing." Copies are available to non-members of the association and may be obtained from R. Cussins of Cussins and Light, Kings Square, York. The price, including postage, is 3d.

Business Radio.—Some of the concerns to which Marconi's have recently supplied or demonstrated "business radio" equipment include the Brighton Waterworks Department and the Grimsby Fishing Fleet. At Brighton 10-watt transmitter-receivers have been installed in the waterworks service and maintenance vans. The master transmitter is located at the reservoir and is remotely controlled over a G.P.O. line from the engineer's office two miles away. Marconi "Seaphone" v.h.f. gear was recently installed in a tug at Grimsby for passing on information regarding the requirements of the incoming trawlers to the pier-head and for receiving berthing instructions.

Tyre Tests.—A decrease of 6db in background noise was registered during tests at Fort Dunlop recently when using a receiver on a car fitted with special conducting rubber tyres.

"Superheterodyne Television Unit."—It is regretted that there has been some delay in issuing the reprint of the articles published in the February and March issues giving details of a long-range unit for the reception of Alexandra Palace. This is now available from our Publisher, price 2s 6d, postage 2d. The modifications necessary to make this unit suitable for the reception of the Birmingham transmissions are described elsewhere in this issue.

More Hospital Television.—Two Marconi Image Orthicon television cameras with associated equipment were installed at University College Hospital, London, for this year's International Gynaecological Congress. Delegates were thus able to watch operations in progress without having to crowd into the small gallery. The 625-line apparatus worked on a closed circuit; viewing was by special Cintel receivers with 20-inch tubes.

Pyve v.h.f. radio-telephony equipment has been ordered by the Ministry of Civil Aviation for the fire service at eighteen civil aerodromes. The equipment for each aerodrome comprises five sets—two master transmitter-receivers and three mobile sets. The sets operate in the 118 to 132-Mc/s aeronautical band and have an output of 12 watts. Each radio-equipped fire appliance has a loud hailer which is fed from the a.f. section of the receiver.

Irish Radio Exhibition, which has not been held for eleven years, is being revived this autumn. It will be held in the Mansion House, Dublin, from September 19th to 24th. The organizing secretary is J. J. McCann, of 67, Grafton Street, Dublin.

Now You Know!—"A radio engineer is a person who passes as an exacting expert on the basis of being able to procreate with prolific fortitude infinite series of incomprehensible formulae calculated with micromatic precision from vague assumptions based on debatable figures taken from inconclu-

World of Wireless—

sive experiments carried out with instruments of problematical accuracy by a person of dubious reliability and questionable mentality." Quoted in the *Journal of the Engineering Society of University College, London*.

G.R.S.E.—It is understood that consequent upon the death of J. A. Corbett, the secretary of the Guild of Radio Service Engineers, R. F. Howard is temporarily acting as secretary. Correspondence should continue to be sent to 37, York Road, Holland-on-Sea, Essex.

Amateurs' Choice.—The result of an analysis of the relative interests of members of a west-country amateur radio society in the various branches of radio makes interesting reading. Model control gear came first in order of preference, valves second, communications gear third, and high-fidelity equipment fourth.

Colonial Communications.—Cable and Wireless provided the equipment and operators for the "Round the Colonies by Cable" exhibition which has been held for the past six weeks in the *Daily Express* building in Fleet Street. Visitors were able to hand in written questions for certain Colonial stations, from which replies were received within a few minutes. Despite the title wireless was used for some of the routes.

Aiding Motorists.—In order to increase the operational range of the v.h.f. radio-telephone equipment installed at the H.Q. of the Automobile Association for communication with its breakdown vans, a 60ft tower has been erected on the roof of the building. Both the fixed and mobile stations, which were supplied by Marconi's, are crystal controlled and have an output of 10 watts.

Institute of Physics.—An increase of 187 in the membership of the Institute is recorded in the annual report. The total at the end of the year, including 818 students, was 3,455.

Metals and Alloys.—Although not directly concerned with radio, some readers may be glad to learn of the publication of a fifth edition of "Metals and Alloys," a 214-page book listing some 4,600 compositions. It is issued by the Louis Cassier Co., and distributed by our Publisher, price 15s.

Engineers' Guild now has a Western branch—the sixth—with headquarters in Cardiff.

FROM ABROAD

Denmark has ordered a new 100-kW medium-wave broadcast transmitter from Marconi's. The transmitter, which is expected to be operating by the end of next year, will be erected at Skive, Western Denmark.

U.S. Television Stations.—According to an F.C.C. analysis of the applications for licences for television transmitters over 31 per cent (which represents 128 stations) have been made by newspaper proprietors. The next highest in the list are broadcasting companies, 16 per cent (66 stations), and cinemas and theatres, 6 per cent (27 stations).

Navigational Aids.—Ten radio-beacon transmitters operating in the 200 to 415-kc/s band have been ordered by the Indian Air Force from Marconi's. The output of the WB8 transmitter, which is enclosed in a cabinet measuring 6ft by 5ft by 2ft 6in, is 2.5 kW on c.w. and 3.4 kW on m.c.w. Two 150ft masts are used to support a 4-wire 300ft top "T" aerial.



SYMBOLIC of British Radio. The Alexandra Palace television and f.m. aeriels are incorporated in the design of the Radiolympia poster.

Indian Amateurs have formed the Amateur Radio Club of India—for transmitters, and the Short-wave League of India—for non-transmitters. Headquarters are at Mhow, Central India, and the address of the QSL bureau is Post Office Box 6666, Bombay. A monthly journal, *QRZ*, is being issued jointly by these organizations for their members. Two transmitters have been installed at the headquarters with the call signs, VU2ARCI and VU2SWL; they operate in the 7, 14 and 28-Mc/s bands.

Popularizing F.M.—The suggestion is made by our New York contemporary, *Tele-Tech*, that American television receivers should cover the 88 to 108-Mc/s f.m. band. This would increase the potential audience for the service provided by the 750 or more f.m. stations.

INDUSTRIAL NEWS

Redifon, Ltd., is the new name adopted by Rediffusion, Ltd., of Broomhill Road, Wandsworth, London, S.W.18. The change has been made to avoid confusion—the name Redifon having been the trade name of the company for some time, whilst the name Rediffusion has been applied to the system of wire broadcasting operated by the Broadcast Relay group of companies.

New Trademark.—The Truvox Engineering Co. advises us that they have registered the trade name "Wafer" in respect of electro-acoustic and electro-mechanical transducer units for the recording or reproduction of sound.

Celestion.—An announcement from the Board of Celestion, Ltd., states that the company is going into liquidation preparatory to the business being sold.

Philco (Great Britain), Ltd., has vacated its premises at Greenford, Middlesex. All correspondence should be sent to 92, New Cavendish Street, London, S.W.1.

Steatite & Porcelain Products have transferred their London office to Victoria Station House, 191 Victoria Street, London, S.W.1. (Tel.: Victoria 7715.)

Ekco have closed their service depot at 14 Redcross Street, Bristol. Correspondence should now be sent to 1, Brook Street, Birmingham, 3.

CLUB NEWS

Birmingham.—At the meeting of the Slade Radio Society on August 19th the chief engineer of Radiovision, Ltd., will describe and demonstrate the "Commander" receiver. Members of the society are to visit the B.B.C. short-wave station at Daventry on August 21st. An inter-club direction-finding test is being organized by the society on September 18th. Clubs who wish to take part can obtain full particulars from the secretary. Meetings are held on alternate Fridays at 7.45 in the Parochial Hall, Slade Road, Erdington. Sec.: C. N. Smart, 110, Woolmore Road, Erdington, Birmingham, 23.

Carlisle.—Meetings of the Carlisle Amateur Radio Society are being held only once a month during the summer. The H.Q. is Richmond Hall, Y.M.C.A., Fisher Street, Carlisle. Although present members are all transmitters, the club intends to extend its activities to cater for beginners and those interested in short-wave reception. Sec.: J. Ostle, G2DYV, 2, Outgang, Aspatria, Cumberland.

Derby.—"Radio Interference" is the subject of a talk to be given by C. E. Woolley, of the G.P.O. Engineering Department, to members of the Derby and District Amateur Radio Society on August 17th at 7.30 in the lecture theatre, Derby School of Arts, Green Lane. Sec.: F. C. Ward, G2CVV, 5, Uplands Avenue, Littleover, Derby.

Edinburgh Amateur Radio Club has been formed, and regular weekly meetings are being held. Details of the club, which has a membership of 25, are obtainable from David A. E. Samson, 56, Elm Row, Edinburgh.

Southend.—A d.f. contest between the Romford and Southend societies is being held on August 28th. A philanthropic work undertaken by members of the Southend Radio Society is the provision of free receiver maintenance service for the local blind people. Sec.: J. H. Barrance, M.B.E., 49, Swanage Road, Southend-on-Sea, Essex.

TELEVISION RECORDING

Simplified System

By D. A. SMITH, (B.B.C. Television Service)

A BRIEF description of the system developed by B.B.C. engineers for making high-quality recordings of television programmes for subsequent transmission was published last year.* More recently a need has been felt at Alexandra Palace for a rather simpler and more economical system of television recording, intended primarily to enable producers to study their pro-

Three successive pictures from the film recorder are shown here; the sound track is on the left.

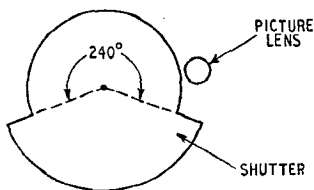
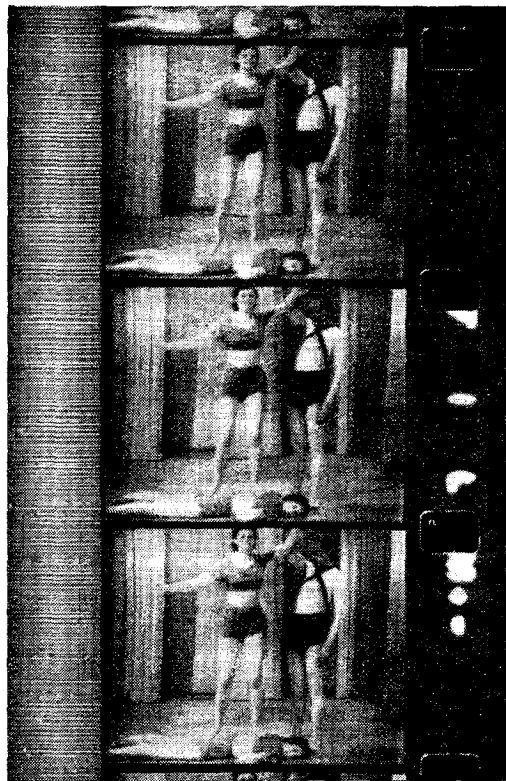

Fig. 1. The arrangement of the revolving shutter which permits an exposure during two consecutive frames and closes the lens during the third, is sketched here.

ductions after transmission and hold post-mortems on them. To meet this need, a system using standard 16-mm film, perforated on one edge and running at 16-2/3 frames per second, has now been developed and is being tried out at Alexandra Palace.

To record all the information on an interlaced television picture, one must be able to photograph consecutive frames; i.e., one odd-line scan and one even-line scan. The method now about to be described photographs two consecutive television frames, and misses the third frame, then photographs the fourth and fifth frames, and misses the sixth frame, and so on. To achieve this the film must remain stationary in the camera gate for at least twice as long as it takes to

move downwards to the next frame. The ratio of the period during which the film is being pulled down to that during which it is stationary is called the pull-down ratio, and it will be seen from the foregoing that this ratio must be 1:2 or greater. The pull-down ratio of most cameras is 1:1, but that of projectors is usually 1:3, which is quite suitable. It was, therefore, decided to modify a standard projector and use it as a camera, running in synchronism with the television transmission. This was achieved by driving the projector with a 3-phase motor running at 1,500 revolutions per minute and connected to the

the motor, so that the projector runs at 16-2/3 frames per second; i.e., a gear-down ratio of 3:2.

A projector was converted by fitting a shutter with an aperture or opening of 240° (Fig. 1) on to the projector-shutter shaft, the shaft having been extended so that the shutter revolves just in front of the lens. (Fig. 2.) In a period of one second fifty television frames are displayed and 16-2/3 film frames pass through

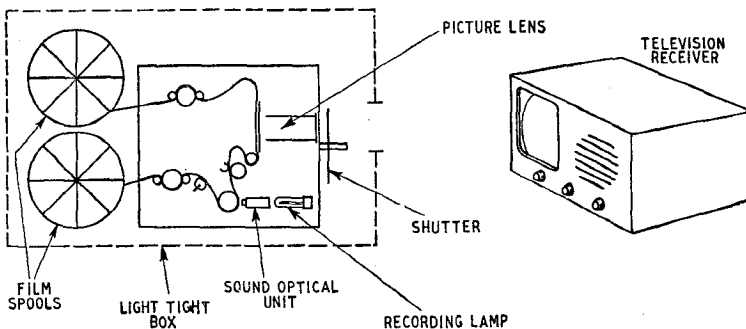

Fig. 2. Layout of the recording equipment.

main electricity supply, to which the television transmission is locked. The projector mechanism is suitably geared down from

the camera. The shutter opening of 240° allows two consecutive television frames to be photographed on one film frame, after

* B.B.C. Quarterly, Vol. III, No. 1, April 1948.

Television Recording

which the shutter closes during the third television frame and the film is moved down to its next position. The shutter next opens

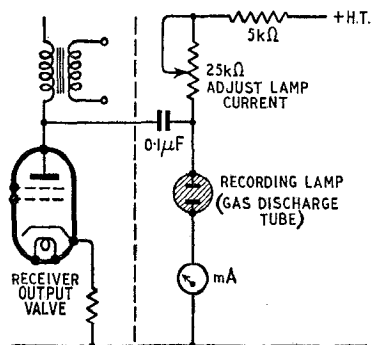

Fig. 3. Method of feeding the recording lamp for the sound signal.

while the fourth and fifth television frames are displayed and closes during the sixth frame and the film is again moved down. Thus two out of every three television frames are photographed. When the film has been processed and is projected on a standard projector having a three-bladed shutter and running at silent speed (i.e., 16 frames per second), very little flicker is apparent, and reasonably good reproduction of the television programme is obtained.

The sound system of the projector was modified to enable the sound component of the programme to be recorded on the film. This modification consists of replacing the exciter lamp with a gas-discharge recording lamp (Fig. 2), and reducing the width of the slit in the sound optical unit to less than $1/4,000$ inch, in order to permit frequencies up to 5,000 c/s to be recorded. The recording lamp is connected to the sound output valve of the receiver as Fig. 3.

With panchromatic film, it is essential that all sources of light should be shielded from the film. For this reason the entire projector is housed in a light-tight box. (Fig. 2). Using Kodak Super X panchromatic film, with a lens aperture of $f/1.9$, an excellent exposure can be obtained with an ordinary television receiver adjusted for normal viewing. Experiments have also

been made using Kodak Positive film (a film very sensitive to blue light, but insensitive to red light) and a receiver modified to give a negative image of rather greater brightness than usual. In this way a very good film negative can be obtained in a positive sense. There are many advantages in using positive film—a sharper picture can be reproduced because the grain size in the emulsion is very much smaller, and the frequency range of the sound track can be extended up to some 6,000 or 7,000 c/s. If the apparatus is set up in a dark room, and the light from the television receiver is screened from the projector and film spools, the projector need not be encased in a light-tight box, and a red safe light can be used while filming, which eases the operators lot by enabling him to watch the progress of the film through the projector.

The silent speed of most 16-mm projectors is about 16 frames per second, and good television recordings can be made by increasing the

shutter aperture to an angle that is dependent on the film speed. The formula for calculating this angle is:—

$$\text{shutter aperture} = \frac{\text{film frame speed}}{\text{television frame frequency} \times 360 \times 2 \text{ degrees}}$$

Thus for a projector running at 16 frames per second in conjunction with the B.B.C. television service:—

$$\text{shutter aperture} = \frac{16}{50} \times 360 \times 2 = 231 \text{ degrees.}$$

Using Super X panchromatic reversal film, a transmission lasting one hour can be filmed at a cost of about £25. If positive release film is used the cost is only about £10 for an hour's programme.

This description has been confined to a system using 16-mm film, but the same system is equally applicable to 35-mm or 9.5-mm film. On 35-mm film, of course, a picture of rather better quality can be obtained, but the cost is much greater.

TELEVISION AERIAL TESTER

DESIGNED to measure the signal voltage appearing at the end of the aerial feeder, this instrument consists of a battery-operated 7-valve superheterodyne tunable over the range of 40-50 Mc/s. The

output is fed to a meter which is calibrated in microvolts. A three-range attenuator is included in the i.f. amplifier and the full range of $100 \mu\text{V}$ to 100 mV is thus obtained in three steps. A loudspeaker is included so that an audible signal can be obtained.

The instrument measures $9\frac{1}{2}$ in by $5\frac{1}{2}$ in by 13 in and weighs 18 lb including batteries. It was designed for Rediffusion Ltd. by British Communications Corp., Ltd., of Gordon Avenue, Stanmore, Middlesex, to which firm any enquiries should be addressed.

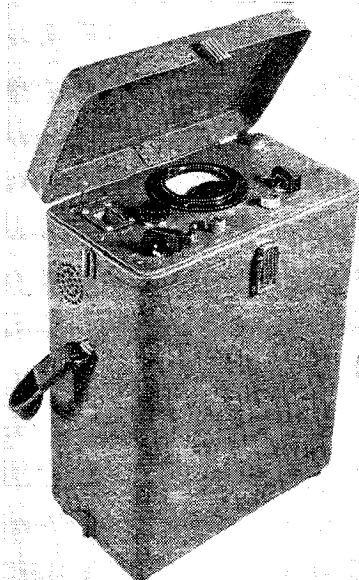

Rediffusion television aerial tester.

RUBY NEEDLES

GRAMOPHONE needles of the straight-shank, trailer and miniature type with ruby tips are being marketed by Brooks & Bohm, 90, Victoria Street, London, S.W.1. Ruby is a variety of corundum and belongs to the same group as sapphire, of which there are white and blue types, depending on the nature of the colouring impurity. Corundum has a hardness of 9 on the Mohs scale (diamond is 10) and there are slight variations according to the method of production. The makers claim that their ruby is superior to sapphire and will have a longer life.

The retail price is 7s 6d each.

Vortexion

SUPER FIFTY WATT

This **AMPLIFIER** has a response of 30 c/s. to 25,000 c/s. within $\frac{1}{4}$ db, under 2 per cent distortion at 40 watts and 1 per cent at 15 watts, including noise and distortion of pre-amplifier and microphone transformer. Electronic mixing for microphone and gramophone of either high or low impedance with top and bass controls. Output for 15/250 ohms with generous voice coil feedback to minimise speaker distortion. New style easy access steel case gives recessed controls, making transport safe and easy. Exceedingly well ventilated for long life. Amplifier complete in steel case, with built-in 15 ohm mu-metal shielded microphone transformer, tropical finish.

As illustrated. Price **36½ Gns.**

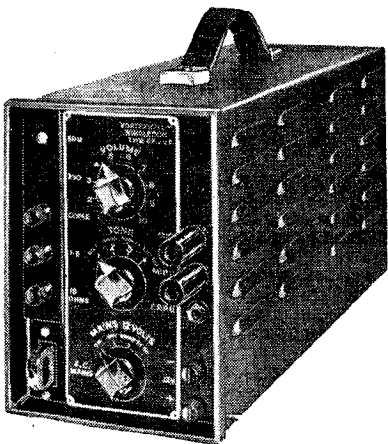

CP20A. 15 WATT AMPLIFIER



for 12 volt battery and A.C. Mains operation. This improved version has switch change-over from A.C. to D.C. and "stand by" positions and only consumes 5½ amperes from 12 volt battery. Fitted mu-metal shielded microphone transformer for 15 ohm microphone, and provision for crystal or moving iron pick-up with tone control for bass and top and outputs for 7.5 and 15 ohms. Complete in steel case with valves.

As illustrated. Price **£28 0 0.**

30 WATT RECORD REPRODUCER

This amplifier has been produced for extremely high quality gramophone or microphone quality in large halls or in the open. An output power of 30 watts is obtainable at under 1% distortion after the output transformer which is arranged for 4, 7½, or 15 ohm output. The most noticeable point is the absence of background noise or hum. Very generous feedback is employed to help out any distortion developed by the speaker and the large damping factor ensures good transient response. The usual response of 30 to 25,000 cycles plus or minus $\frac{1}{2}$ db is given, and recording compensation of 5 db per octave lift below 300 cycles is obtainable on the gramophone input by means of a switch. A carefully balanced treble control is arranged to correct top lift on some recordings as well as to reduce scratch on old records without noticeable effect on frequencies below 3,500 to 4,000 cycles. The input is intended for the high fidelity type of pick-up and is fully loaded by an input of .2 volts on 100,000 ohm or $\frac{1}{2}$ meg. ohm as required. The microphone stage requires an input of .3 millivolts on 15 ohm balanced line through the wide response mumetal shielded microphone transformer. An octal socket is fitted at the rear of the chassis to provide power for feeder units, etc., 6.3 volts at 2 amps and 350 volts at 30 milliamps is available.

Complete in well ventilated steel case. Price **30½ Gns.**

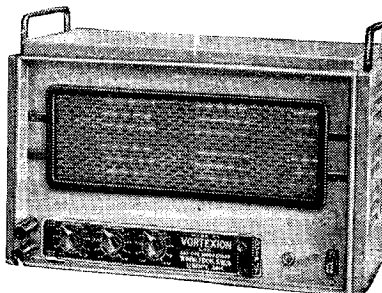

EXPORT

Enquiries from Overseas will receive prompt attention. Continental Buyers are invited to get into touch with our Belgian Agents:

Ms. Constant J. Bisman,
129 Avenue de la Reine,
Bruxelles
Téléh. 16.10.31.

FOUR WAY ELECTRONIC MIXER

This unit has 4 built-in, balanced and screened microphone transformers, normally of 15-30 ohms impedance. It has 5 valves and selenium rectifier supplied by its own built-in screened power pack: consumption 20 watts. Suitable for recording and dubbing, or large P.A. Installations since it will drive up to six of our 50 watt amplifiers, whose base dimensions it matches. The standard model has an output impedance of 20,000 ohms or less, and any impedance can be supplied to order. Price in case with valves, etc., **£24.**

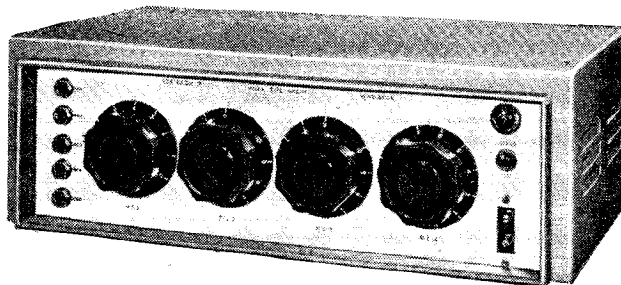

VORTEXION LIMITED, 257-261 THE BROADWAY, WIMBLEDON, LONDON, S.W.19

Telephones: LIB 2814 and 6242-3

Telegrams: "Vortexion, Wimble, London"

G.E.C.

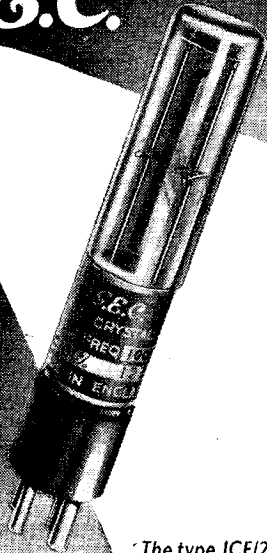

QUARTZ CRYSTAL UNITS

FOR STABLE FREQUENCY GENERATION

FEATURES

Low temperature co-efficient — less than 2 in 100,000.
 Patented nodal suspension. Mounted in vacuum: performance independent of climatic conditions. Exceptionally high Q value.
 High stability. Small size, 3" x $\frac{5}{8}$ " overall excluding pins. Fits standard miniature deaf aid valve socket.

FOR FREQUENCY SUB-STANDARDS

Type JCF/200, 100 KC/S. Available from stock adjusted to 0.01%. Higher accuracies supplied to special order.

PRICE

£2 - 15 - 0

The type JCF/200 unit illustrated is representative of the wide range of vacuum type unit available for low and medium frequencies.

SALFORD ELECTRICAL INSTRUMENTS LTD.

PEEL WORKS, SALFORD 3, LANCs. Telephone BLAckfriars 6688 (6 lines). Telegrams & Cables SPARKLESS Manchester

Proprietors THE GENERAL ELECTRIC CO., LTD., OF ENGLAND

* S.R.E. for all purposes

Philips have supplied through traders and others throughout the world S.R.E. for almost every conceivable application. While specialized equipment is produced whenever necessary, a very wide range of standard apparatus units minimizes the need for this, and simplifies installation and maintenance.

As it can be shown to be much better engineering practice to use one large amplifier instead of a lot of little ones to feed one load, the standard range includes three large rack amplifiers.

Features include triode valves throughout, four push-pull stages, no electrolytics, and three separate anode supplies.

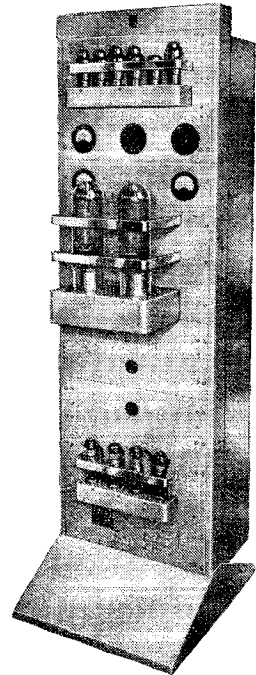

- 250 watt**List Price **£255**
- 500** "List Price **£325**
- 1,000** "List Price **£425**

S.R.E. available through the trade on hire purchase or rental terms.

* What expression should be used to refer generally to amplifiers, and related apparatus? "Public Address?" This hardly applies to gear that may well be used in private for purposes other than addressing. "Sound Equipment?" This can also mean tom-toms, or brewery apparatus in sound condition!

We have adopted the Navy's term "S.R.E." or "Sound Reproducing Equipment", as in our submission there is no other so accurate or so generally applicable.



PHILIPS ELECTRICAL

LIMITED

Amplifier Dept., Century House, Shaftesbury Avenue, London, W.C.2. (A481)

MILLER EFFECT

Step-by-Step Resolution of Some of Its Paradoxes

By "CATHODE RAY"

ONE of the stickiest patches in valve circuit theory seems to be Miller effect with reactive load. Why should an inductive anode circuit look like a negative resistance when viewed from the grid? Even those who are prepared to accept a mathematical proof of this curious fact generally find its action difficult to visualize.

Several readers have asked me to make this clearer for them; and in case there are some who are not too happy even with a simple resistive load I propose to start right from the beginning, taking the thing by easy stages. The difficulty arises from trying to think of the whole problem at one go.

Very well, then.

In discussing circuits one often talks about parts of them "looking like" something else. This sort of statement may sound rather casual and unscientific to the uninitiated, but actually it has quite a precise meaning. Fig. 1 (a) shows a celebrated example. One may say that at resonance the circuit LCR looks to the generator (E) like a resistance R, as shown in Fig. 1(b).

C are usually much greater than that across R. What it does mean is that so far as the magnitude and phase of the generator current is concerned there is no difference between (a) and (b). If LCR were

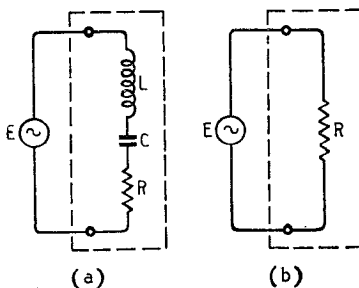

Fig. 1. The generator here (and in other diagrams) represents any source of voltage, E. So long as its frequency is equal to the resonant frequency of the circuit LCR(a), it makes no difference so far as the generator is concerned if L and C are removed, leaving only R(b).

shut up in a box provided with terminals, one would be unable to tell by any external measurements of the current and voltage that the box contained L and C as well as R.

altered, so that the circuit is no longer at resonance, it no longer looks anything like Fig. 1(b). At any particular frequency, however, another equivalent could be calculated, which would include only resistance and inductance or capacitance.

Forgive me if all that is painfully familiar, but it is important to be quite clear from the start about the trick of using circuit equivalents. We shall be doing it steadily from now on.

Imagine another of these mysterious sealed boxes with terminals, and that you are provided with as many batteries and a.c. generators and meters as you like, and have been asked to find out what circuit there is inside. And suppose that whatever you connect to the terminals you can detect no trace of current, either continuous or transient. You will probably report that the terminals are open-circuited. And you might easily be right. On the other hand you might be wrong. Because for all you know there may be a small but extremely

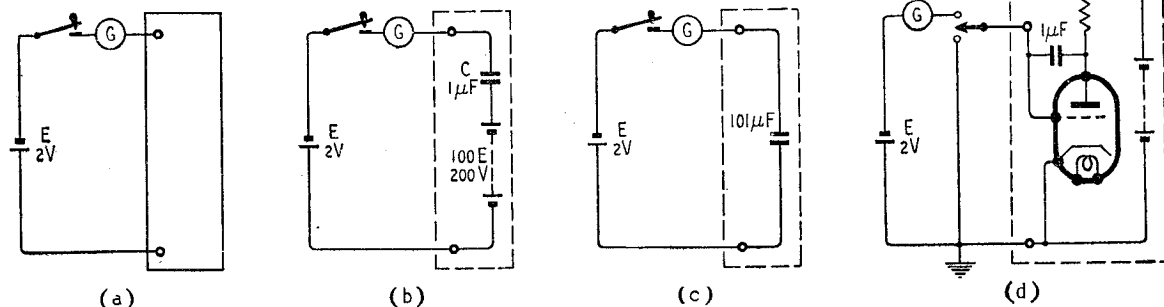

Fig. 2. If by any means an internal voltage is introduced which is always 100 times the applied voltage E(b), it makes the capacitance seem to be 101 times larger than it really is (c). One way in which this internal voltage can be introduced is by means of amplification (d).

That is not, of course, intended to mean that LCR is the same thing as R; obviously it is not, because the voltages across L and

Such statements usually have conditional clauses; in this case, "at resonance." Directly the frequency of the generator is

efficient demon inside the box, always connecting a low-resistance battery or generator exactly equal and opposite in voltage to any you

Miller Effect—

connect. If so, although the resistance between the terminals would be low, to you it would "look like" an infinitely high resistance.

I hope you haven't thrown this line of argument aside with contempt as vain superstition, unworthy of *Wireless World*—even of "Free Grid"—for it is just another of these convenient and quite legitimate equivalents. The precise mechanism by which the internal voltage was kept so exactly equal to whatever you might have chosen to apply externally was unimportant, and it was less fatiguing to invoke a demon than to think out some more humdrum electronic device, which by its sheer ingenuity might have distracted attention from the main conclusion, viz., that the presence in a circuit of a voltage proportional in some way to the applied voltage may make the circuit impedance behave exactly like some quite different impedance.

Suppose now that the box contains a real capacitor, as bought from a reputable firm, and guaranteed $1\mu\text{F}$ (within the usual tolerances). You want to make quite sure, however; and as you have a 2-volt cell and a ballistic galvanometer (an instrument for measuring quantity of electricity by the amplitude of the transient deflection), and can recall the textbook formula $C=Q/E$, you connect them up as shown in Fig. 2(a). In the ordinary way of things the galvanometer would indicate a charge of 2 microcoulombs, and knowing the voltage

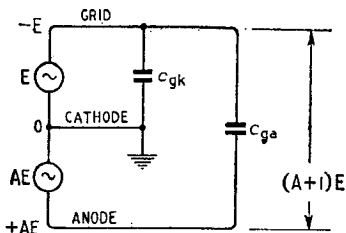
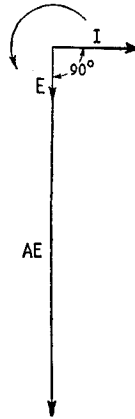

Fig. 3. In this diagram, the input and output voltages of an amplifying valve are represented by the generators giving voltages E and AE respectively, showing clearly how the current through c_{ga} (the grid-to-anode capacitance) may be much larger than it would be if only E were acting, and hence how the capacitance seems to E to be larger.

was 2 you would deduce that the capacitance in the box was in fact $1\mu\text{F}$. But unfortunately the demon has crept in again (b), and has misleadingly inserted a 200-volt battery in such a way as to augment your 2 volts. The charge is therefore actually 202 microcoulombs. When you and the galvo have recovered from your surprise, your version of the incident (seeing that you don't believe in demons) is that the box contained $202/2 = 101\mu\text{F}$, as shown in Fig. 2(c).

If, perhaps, you are more experienced and wary you may suspect that someone has been playing a trick on you by charging up the capacitor when you weren't looking, hoping you would touch both terminals at once. So you short the terminals to discharge it and then try again; perhaps

Fig. 4. Reckoning the voltages E and AE in Fig. 3 from the grid instead of the cathode, they are in phase, as shown in this vector diagram, which also shows the current through c_{ga} leading by 90° .



with the battery reversed. But the demon is too quick for you and he first removes and then reverses his battery. So, still half sceptically, you label the box "101 μF ."

Although the box actually contains only $1\mu\text{F}$ it "looks like" $101\mu\text{F}$, and is in every way equivalent to it.

If you still object to the introduction of supernatural agencies, I will withdraw my demon and Fig. 2(b), and substitute (d). Here is a valve giving a voltage amplification (A) of 100. So when you apply, say, -2V, the anode (to which the other terminal of the $1\mu\text{F}$ capacitor is connected) goes +200V relative to what it was before, just as if the demon were still at work. The total voltage to which the capacitor charges is therefore 202V, and the galvo, if it is still functioning, flicks up to 202 microcoulombs. But the only charging voltage you know about is your 2V, so again you calculate the capacitance to be $101\mu\text{F}$.

This discrepancy between the actual and apparent capacitance arises from the fact that by looking at it from outside the box, ignoring what is going on inside, you are accounting for the charging current by the small charging voltage you apply, whereas the actual charging voltage set in motion by it is (A+1) times as large.

Further experiments would soon show up the limitations of this apparent $101\mu\text{F}$ capacitor; applying a large negative voltage would cause about 99% of its capacitance to disappear, and a positive voltage would (apparently) make it leak. And tests with a.c. would be complicated by the very long time constant—the valve is not so efficient as the demon, because it brings in considerable resistance. But leaving this resistance out of account, and breaking open the box to see what it actually contains, we should now have no difficulty in writing down a formula for the effective or apparent capacitance (C_e) between the terminals:

$$C_e = c_{ga} (A+1)$$

where c_{ga} is the capacitance between grid and anode and A is the voltage amplification. (There is of course always the grid-to-cathode capacitance of the valve, c_{gk} , in the usual nomenclature, to add in; but I shall not bother to mention it every time).

To reduce the time-constant complication to relative insignificance, and at the same time to arrive at a more typical case of Miller effect, we next remove the $1\mu\text{F}$, leaving the interelectrode c_{ga} , which would be only a few pF. But the same principle holds good regardless of the actual amount; the input capacitance of the valve is still (A+1) times as great (plus, of course, c_{gk} , which is charged only by the input voltage, so is not amplified). To take some actual figures from the *Wireless World* Valve Data book, a certain triode with a g_m of 2mA/V has $\mu = 68$ and $r_a = 34\text{k}\Omega$. If these characteristics hold good with a coupling resistance of $50\text{k}\Omega$, the voltage amplification A is $(68 \times 50)/(50 + 34) = 40.5$. c_{ga} is given as 2.5pF and c_{gk} as 3pF; so the effective input capacitance, C_e , is $3 + (41.5 \times 2.5) = 104\text{pF}$. Substituting a comparable pentode, $g_m = 1.8$, $\mu = 2160$, $r_a = 1.2\text{M}\Omega$; A would be 87.

For this valve c_{ga} and c_{gk} are 0.002 and 4pF respectively, so $C_e = 4 + (88 \times 0.002) = 4.18\text{pF}$. Rather a difference! In practice

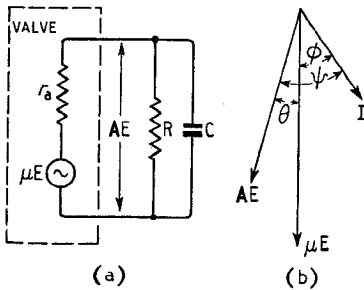

Fig. 5. If the resistance coupling (R) is shunted by capacitance (C) the equivalent anode circuit is as at (a), and the vector diagram as at (b)

any external stray capacitance between anode and grid would have to be added to c_{ga} , and C_e in both cases would be rather larger, especially with the pentode.

Another way of representing the situation is as in Fig. 3, in which the output voltage of the valve, AE , is shown as if it were being produced by a generator synchronized with the source of E . It is negative relative to E if both are reckoned from cathode; but if they are reckoned from grid (which, being one terminal of c_{ga} , is more convenient) they are in phase. This is represented in the vector diagram, Fig. 4. (If the frequency were high enough, the reactance of c_{ga} and c_{ak} would offer an appreciable bypass to the anode load resistance, and would throw the output voltage out of phase; but we are assuming that the frequency is not so high, or else that the effect of capacitance on the anode load impedance is neutralized by inductance). The voltage at the grid has an entirely capacitive load, so its current vector must be 90° leading (I in Fig. 4, remembering that the diagram conventionally rotates anti-clockwise).

Well, that is the particular case of Miller effect in which the output voltage of the valve is exactly opposite to the input (relative to cathode or earth) and exactly in phase with it (relative to grid)—the case in which the anode load is purely resistive, whether it consists actually of a coupling

resistor, or only looks like one, being actually a parallel-resonant circuit. Most people can follow it quite easily because the input and output voltages are in line with one another and so add up across the grid-to-anode capacitance by simple arithmetic. It is when the anode load is reactive that the trouble starts. But it will be all right if we tackle it bit by bit.

A reactive anode load may consist of a tuned coupling such as an i.f. transformer at some off-tune frequency, or an audio transformer at very low or very high frequencies, or even the resistance shown in Fig. 2(d) at very high frequencies, when the effect of stray capacitance across it is appreciable. Let us take the last case first, and examine it with the help of the "valve equivalent generator," Fig. 5(a).

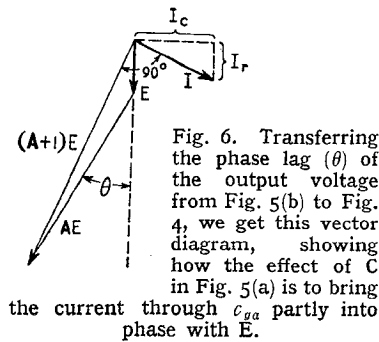

Fig. 6. Transferring the phase lag (θ) of the output voltage from Fig. 5(b) to Fig. 4, we get this vector diagram, showing how the effect of C in Fig. 5(a) is to bring the current through c_{ga} partly into phase with E .

Here the valve is represented by a generator giving a voltage μ times the input voltage E , (reckoned from grid) in series with its own internal anode resistance r_a . R shunted by C forms its load.

As the whole circuit (r_aRC) is partly capacitive, the current will lead the generator voltage by some angle which we will call ϕ , depending on the proportions of capacitive reactance to resistance. This is shown in the vector diagram, Fig. 5(b).

If the load (RC) had been purely capacitive, this current would have led the voltage across the capacitance by 90° , so the voltage across the load would have had to be drawn 90° behind the I vector. But in practice there must be a conducting path, R , for the d.c., so the load cannot be wholly capacitive. But at least it will be relatively more

capacitive than the whole circuit r_aRC , and so the phase angle between its current and voltage will be greater than ϕ . Let us call it ψ , and draw in the output voltage vector AE , in the diagram. The black letter A is to show that it is a vector quantity.

What we have discovered from Fig. 5 is that the effect of a capacitive reactance in the load is to make the output voltage lag behind the internally generated voltage, μE , which is in phase with the input voltage reckoned from the grid, E . It is a matter of ordinary a.c. calculation to determine the actual angle of lag, and the magnitude of A , from any given circuit data.

We now know that with a capacitive load the output generator AE in Fig. 3 is synchronized with E at a different phase angle, so that the current through c_{ga} will also shift its phase from what is appropriate to a pure capacitance fed from E , and will "look" to E like something different. It is easier to see what by constructing a revised vector diagram. We know from Fig. 5(b) that AE must be replaced by AE , lagging by an angle $(\psi - \phi)$, which we can rename θ . So we can draw the diagram, as Fig. 6. The total voltage across c_{ga} is, of course, the sum of the input and output voltages, $E(A + 1)$. And, as c_{ga} is a pure capacitance, the current through it (I) leads its voltage by 90° . When this current vector is added in Fig. 6 we can see what we have been trying to find all the time—that when the anode load becomes capaci-

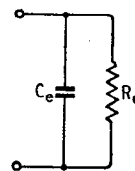

Fig. 7. Effective input circuit of a valve when its anode load is partly capacitive, as shown in Figs. 5 and 6.

tive the current vector I tends to pull into phase with E . In other words, to the input voltage the valve looks like a mixture of capacitance and resistance. So far as input current is concerned, the valve could be replaced by the circuit shown in Fig. 7, in which the component of current still at right angles to E (I_c in Fig. 6) is accounted for by the

Miller Effect—

path C_e , and the new component in phase with E (I_p) is accounted for by R_e .

The interesting thing is that the grid circuit now appears to conduct, even although true conduction may be entirely prevented by grid bias. The more capacitive the anode circuit, the more conductive is the grid circuit. Generally this is even more undesirable than a high input capacitance, because capacitance can be tuned out, whereas the conductance damps any tuned circuit supplying signal voltage to the grid. Hence the preference for screen-grid valves, in which c_{ga} is very small.

Before going on, it might be as well to take a final look at Fig. 3 and visualize the generator AE shifting in phase so that the current through c_{ga} is no longer 90° in front of E , and therefore no longer what E would expect from a true and pure capacitance.

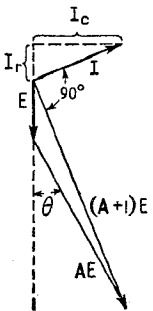

Fig. 8. Vector diagram corresponding to Fig. 6, but with the load inductive instead of capacitive. The component of current in phase with E is negative, indicating a negative input conductance.

E , of course, knows nothing about the demoniacal A in the box, and can only suppose that the strangely inflated c_{ga} has developed a leak.

It should not be too difficult, with the help of Fig. 6, to arrive at the actual formulae for the values of C_e and R_e in Fig. 7—the equivalent input circuit. Taking C_e first, the component of AE in phase with E is $AE \cos \theta$. So the capacitive part of the current through c_{ga} is $(1 + A \cos \theta)$ times as large as it would be if E were the only e.m.f. acting; and therefore:

$$C_e = c_{ga} (1 + A \cos \theta) \dots (1)$$

plus, of course, c_{gk} . The component of AE at right angles to E is $AE \sin \theta$; so the resistive component of current through c_{ga} is this voltage divided by the impedance of c_{ga} , and is therefore

$AE \sin \theta \omega c_{ga}$. The input conductance, I/R_e , is this current divided by the input voltage E ; so we have:

$$I/R_e = -A \sin \theta \omega c_{ga} \dots (2)$$

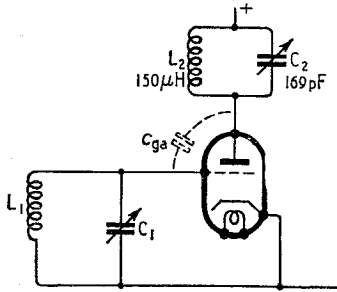

Fig. 9. If L_2C_2 is tuned to exactly the same frequency as L_1C_1 , at which it is equivalent to a pure resistance, why should it not amplify stably?

I have expressed it in the form of a conductance, rather than the resistance R_e , because it is the conductance that is responsible for the disturbing effects.

The negative sign comes in this way: with a capacitive load, θ is a lagging angle, as already explained; lag is conventionally denoted by a negative sign; the sine of a negative angle between 0 and 90° is negative, but the corresponding component of current, as can be seen from Fig. 6, is in phase with E and therefore implies a positive resistance or conductance. So a second negative sign is necessary to neutralize the one brought in by θ .

You will see the importance of this sign if you go through the whole argument relating to Figs. 5 and 6 again, substituting an inductance for C in Fig.

Fig. 10. These curves show the circuit L_2C_2 in Fig. 9 becomes highly inductive at a frequency only very slightly lower than the resonant frequency.

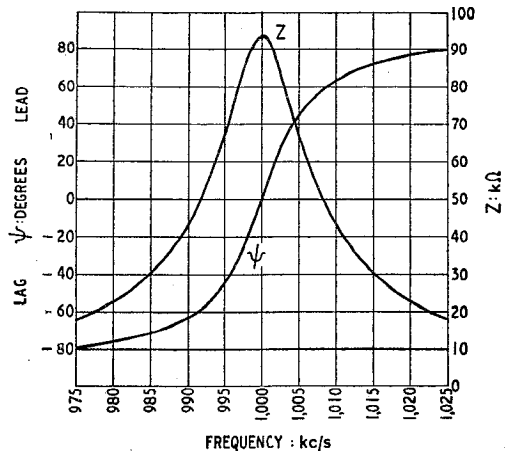

5(a). I needn't write it all out in full, because it should be quite clear that θ will be a leading angle, so that the vector diagram corresponding to Fig. 6 will be something like Fig. 8, in which the hori-

zontal component of I leads E by 90° , indicating input capacitance, as before, but the vertical component is in opposition to E , indicating negative resistance or conductance. This agrees with the formula again, because θ is now positive. The only change in Fig. 7 is that R_e is negative. So if C_e is tuned by an inductance connected across the input to the valve, and $-R_e$ is sufficient to neutralize the positive resistance of the coil and other losses, it will oscillate.

There is one other thing that is commonly misunderstood—the application of the above result to the tuned-grid, tuned-anode circuit (Fig. 9). Every experimenter knows that this is a very reliable oscillator, in spite of needing no back-coupling other than the accidental one via the anode-to-grid capacitance (c_{ga}) of the valve. And that for this reason it is useless as a r.f. amplifier, unless most of c_{ga} is abolished by means of the screening provided in a tetrode or pentode. Yet one might suppose that it would be a simple matter to obtain stable amplification even with a triode, by tuning both L_1C_1 and L_2C_2 to the frequency to be amplified. Then at that frequency L_2C_2 would be equivalent to a resistance and the only thing fed back to the input would be capacitance, which could easily be allowed for

in adjusting C_1 . Or by detuning L_2C_2 slightly, making it slightly inductive, enough negative resistance could be fed back to compensate for the losses of a cheap L_1C_1 and sharpen up the tuning.

It all sounds very plausible. But try it, and I shall be surprised if you find it works out like that.

The snag can be explained by referring to Fig. 10, which shows the impedance and phase angle of a typical tuned circuit ($Q = 100$) adjusted to resonate at 1,000 kc/s. At that frequency the impedance is about $94k\Omega$ and the phase angle is zero, so if the circuit is used as L_2C_2 in Fig. 9 it is equi-

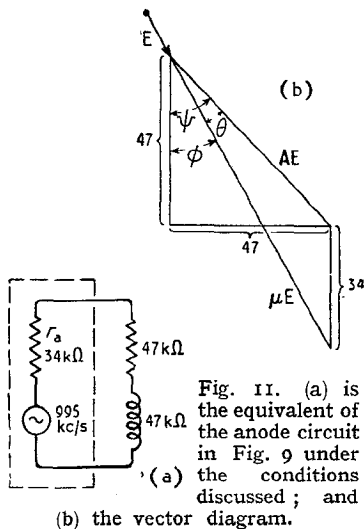

Fig. 11. (a) is the equivalent of the anode circuit in Fig. 9 under the conditions discussed; and (b) the vector diagram.

valent to a $94k\Omega$ resistance coupling. If the triode has the same characteristics as the one we used earlier as an example, the fed-back capacitance would be $2.5 \left(\frac{68 \times 94}{94 + 34} + 1 \right) = 2.5 (50 + 1) = 127 \text{ pF}$. Assuming that C_1 is adjusted to allow for this, why shouldn't we get a perfectly good 50-fold r.f. voltage amplification at 1,000 kc/s?

The answer is to consider what is happening at, say, 995 kc/s. Here the impedance is $67k\Omega$ and the phase angle is -45° . Being a lag, this indicates inductive reactance, amounting to $47k\Omega$, in series with a resistance which is also $47k\Omega$. So we have the equivalent circuit shown in Fig. 11(a). The current is in phase with the voltage across the resistances, and at right angles to the voltage across the inductive reactance. Drawing vectors proportional to the resistances and reactance, to represent the voltages across them, we get Fig. 11(b). The angle between current and output voltage, which as we have

already noted is 45° , is marked ψ , as in Fig. 5 (b); and the angle between the current and internal generator voltage (ϕ), as measured from the diagram, is just over 30° . So the angle θ between output and input voltage is the difference, approximately $+15^\circ$. The magnitude of A can also be derived from the diagram; it is 48.

Inserting these values in equations (1) and (2) we get:

$$C_e = 119 \text{ pF}$$

$$R_e = -5100\Omega.$$

A negative resistance as low as this is a very powerful provoker of oscillation—it is capable of causing oscillation in any circuit (resonant at 995 kc/s) which has a dynamic resistance of $5.1k\Omega$ or more. Assuming circuit L_1C_1 is the same as L_2C_2 , it has a dynamic resistance of $94k\Omega$ at 1,000 kc/s and almost as much (shunted by an inductive reactance) at 995 kc/s. 995 kc/s is only 0.5% less than 1,000 kc/s, yet this slight mistuning transfers nearly 20 times as much negative conductance into the input circuit as is needed for oscillation. Since $\sin \theta$ is nearly proportional to θ for small angles, we can guess that the conditions for oscillation would be fulfilled at a frequency something like 0.03% less than 1,000 kc/s.

Calculating the actual frequency of oscillation is rather more complicated a business; but this simple approach may be sufficient to show that the stability of the Fig. 9 circuit is a fallacy—as of course we all know by experience.

If the anode circuit is tuned to a frequency higher than that of the grid, then of course it will be an inductive load, liable to cause oscillation if the circuit values permit. On the other hand if the anode circuit is tuned to a lower frequency, possibly by adding inductance, it will be a capacitive load, tending to damp out oscillations. If this paradox of making a circuit less inductive by adding inductance sounds puzzling, think it out with the help of Fig. 10. Suppose both L_1C_1 and L_2C_2 are tuned to 1020 kc/s. To make L_2C_2 fit Fig. 10 it is necessary to tune it to a lower frequency (1000 kc/s) by increasing L_2 or C_2 or both. Suppose it is done by increasing L_2 . Then Fig. 10 shows that at 1020 kc/s (the input frequency)

New TRIX Quality SOUND EQUIPMENT

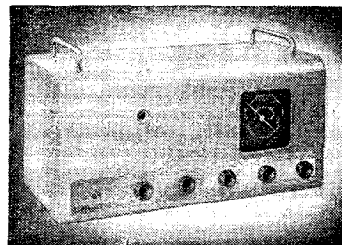

Model RA101 -for SCHOOL BROADCASTING

and small installations in Hotels, Clubs, Factories, etc.

Approved by the School Broadcasting Council for U.K.

This new model has been designed to meet the demands of Educational authorities and other users for broadcasting installations giving high quality reproduction.

The complete unit is mounted in a well finished grey metal case, with chromium handles. It incorporates the radio receiver unit, superhet type, covering three wavebands, together with amplifier unit giving fully 12 watts undistorted output. Individual tone control circuits for Bass and Treble boost are incorporated. In order to ensure correct tuning, the radio unit is fitted with a Magic Eye tuning indicator, making a total of 9 valves.

Inputs are also provided for the addition of a gramophone turntable unit or a microphone, and adequate gain is provided for this purpose. The output circuit is high impedance, allowing a number of external speakers to be attached on long lines, without loss of power.

Send for full details of this and other Trix Quality Sound Equipment

THE TRIX ELECTRICAL CO. LTD.
1-5 Maple Place, Tottenham Court Road
London, W.1. Phone: MUSEum 5817.
Grams & Cables: "Trixradio, Wesdo London"

AMPLIFIERS * MICROPHONES * LOUSPEAKERS

Miller Effect—

its current has a leading phase angle, so is a capacitive load.

If this is still not perfectly convincing, imagine that the anode load consists of an a.f. transformer shunted by a r.f. bypass capacitor. As a tuned circuit, this would

resonate far below 1000 kc/s. The inductance is very high indeed. So high, in fact, that it can be regarded as a complete barrier to r.f. currents in comparison with the capacitive bypass. To them the circuit is capacitive.

The paradox arises, as I

explained a few months ago,* out of the relationship between impedance and admittance. The greater the inductive impedance the greater by comparison is the capacitive admittance.

* "Admittance," Jan., 1949.

BIRMINGHAM TELEVISION RECEPTION

Modifying the "Wireless World" Superheterodyne Unit

WHEN describing the Superheterodyne Television Unit for the *Wireless World* Television Receiver it was said that the changes needed to make it suitable for the reception of the Birmingham station would be described later. It was expected that the changes would be to three coils only.

As the Birmingham station is not yet in operation it is obviously impossible to test the modified receiver on the actual television reception, but signal-generator tests indicate that it should behave correctly. As single-sideband transmission will be used, there is always the possibility that some further minor changes might be needed, but this is considered unlikely.

The alterations needed to the Superheterodyne Unit are confined

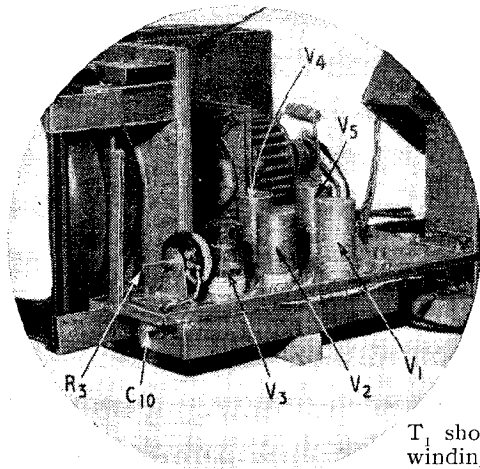

to the three coils T_1 , T_2 , and L_1 of the original circuit diagram and to one minor circuit alteration. The coil formers are unchanged

T_1 should have 10 turns for the winding 1-2 and $1\frac{1}{2}$ turns for 3-4, instead of the $12 + 1\frac{1}{2}$ turns used for Alexandra Palace. T_2 should have one winding of 6 turns instead of the double winding of 9 turns. The turns are spaced out

to fill the winding space available—the $1\frac{1}{2}$ turn coupling coil in T_1 being interwound at the earthy end—and No. 36 d.s.c. wire is used. The oscillator coil L_1 has 8 turns of No. 20 enamelled wire close wound instead of the original 15 turns.

The circuit change consists of the use of a tuned-anode coupling for T_2 instead of a double-wound

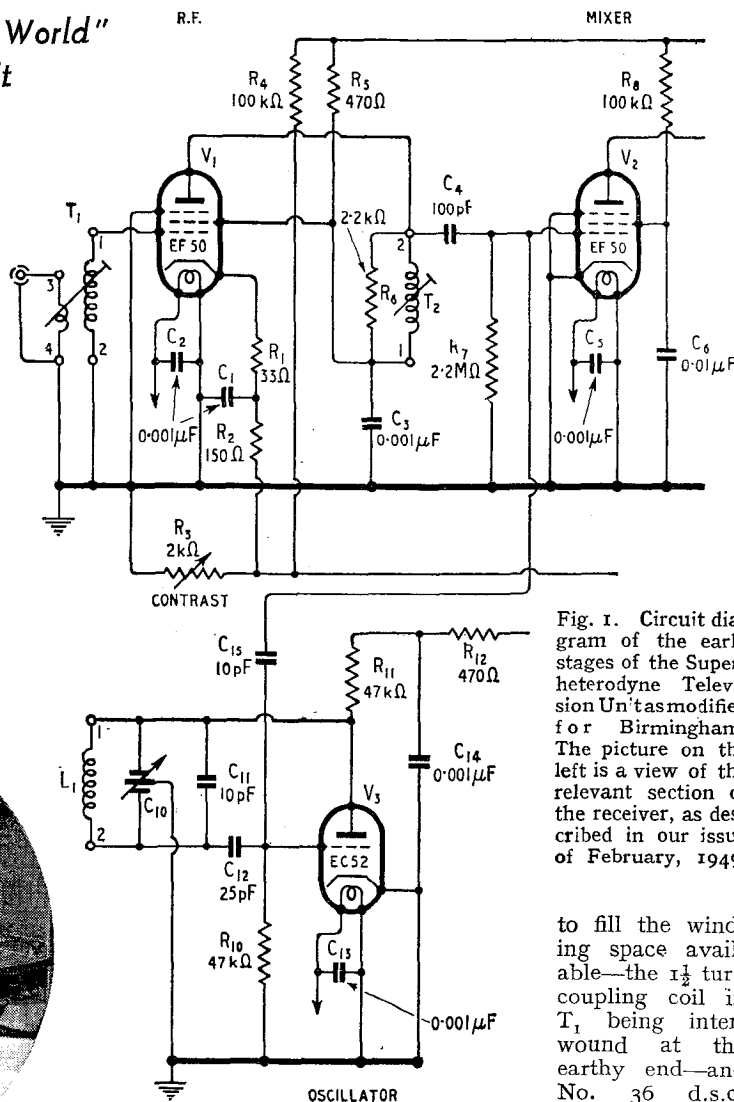

Fig. 1. Circuit diagram of the early stages of the Superheterodyne Television Unit as modified for Birmingham. The picture on the left is a view of the relevant section of the receiver, as described in our issue of February, 1949.

to fill the winding space available—the $1\frac{1}{2}$ turn coupling coil in T_1 being interwound at the earthy end—and No. 36 d.s.c. wire is used. The

transformer. The latter is generally to be preferred, since it permits the complete isolation of the return leads to the cathodes of the two valves and so reduces chassis currents. In this instance, however, it was found to be unsatisfactory because it proved impracticable to secure sufficiently tight coupling between the two windings with so few turns in each. The tuned-anode form of intervalve coupling has been adopted, therefore, and is satisfactory in the single-stage amplifier used in this set.

The circuit of the early part of the unit has been re-drawn in Fig. 1 to show this modification. If it is compared with the original diagram, the change can be seen to be a very minor one.

Since the sound and vision carriers are at 58.25 and 61.75 Mc/s respectively the oscillator must operate at 48.75 Mc/s, while the

signal circuits should be tuned to 59 Mc/s and 61.5 Mc/s for T_2 and T_1 respectively.

The alignment procedure described in the original article is unchanged except for the frequencies to which the signal-generator must be set while adjusting the signal and oscillator circuits. Frequencies for adjustments in the i.f. amplifiers remain unaltered.

This original procedure should, therefore, be followed exactly, but wherever 41.5 Mc/s occurs in the description substitute 58.25 Mc/s. Similarly, for 44 Mc/s substitute 60.75 Mc/s and 61.75 Mc/s for 45 Mc/s. T_2 is to be adjusted with the signal-generator at 59 Mc/s instead of 45 Mc/s and T_1 with it at 61.5 Mc/s instead of 45 Mc/s.

Of course, the aerial must be modified for the higher frequency. The dipole length should be about 7ft 6in instead of 10ft 6in.

VERSATILE TEST SET

Taylor Circuit Analyser

WITH this instrument, aided only by signals from a broadcast station, it is possible to carry out a complete investigation of any fault in a broadcast or television receiver. The main unit contains a triode valve functioning as an a.f. amplifier, a loudspeaker, a magic eye indicator and switching for selecting various methods of test. Included is an a.c. mains supply unit, input and output sockets and an octal valveholder into which can be plugged a separate probe unit.

This probe is used for all r.f. tests and it functions as an aperiodic detector over a very large band of frequencies. Without any other aid an audible signal from the main unit was heard with the probe connected to the feeder from a television aerial in the heart of London.

When looking for a defect in a receiver the set can be tuned to the known position of the local broadcast station and the r.f. probe used to explore, stage by stage, from the aerial socket to the loudspeaker. Signals will be heard from the built-in loudspeaker up to the point in the set where the defect lies and it should then be a simple matter to isolate and locate the trouble.

Apart from fault tracing the analyser can be used to search for possible weaknesses in de-coupling components, for when exploring with the probe signals should be audible on one side of the by-pass capacitors but not on the other.

For most audio tests the signal is injected into the main unit via the input terminals, amplified and passed to either the loudspeaker or headphones as required.

The magic eye can also be used for audio tests but without amplification. Normally this indicator will be employed for d.c. tests and as it imposes no load on the circuit it is ideal for checking a.g.c. circuits.

This versatile test set is listed as the Model 20A Circuit Analyser and the price is £15 15s. The makers are Taylor Electrical Instruments, Ltd., 419-424, Montrose Avenue, Slough, Bucks.

Taylor Circuit Analyser
Model 20A.

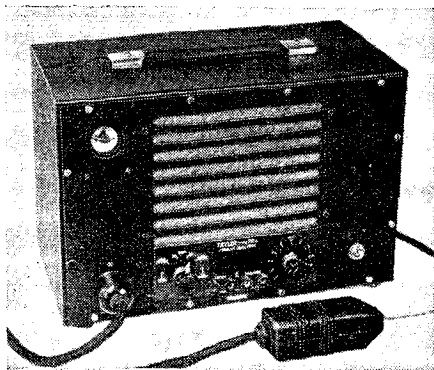

M. WILSON LTD

"White Rose Radio"

TELEVISION CIRCUIT for HOME CONSTRUCTORS

Built on one chassis only, 9in. black and white magnetic tube.

EASY TO BUILD. RELIABLE, SAFE.

Two models. London or
Birmingham.

Full specification upon request.

Blue Prints. Two full-size practical, and theoretical, and priced list of parts. 10/6

A NEW HIGH FIDELITY TUNING UNIT

Brief specification.

One R.F. stage, F.C. with separate oscillator, 1 stage of I.F., using our new I.F. Transformers, iron cored, permeability tuned, with a "Q" of 155, feeding into second detector of the cathode follower type, using our new Audio filter unit.

Fitted with its own power pack and smoothing ready to attach to any good L.F. amplifier.

CONTROLS

Main tuning control, no band-spread required, sensitivity control working on the first R.F. valve. I.F. gain control with selectivity control incorporated. 6 wave-band switch. The chassis is built of 16 s.w.g. aluminium, rigid corners Box type 6 wave-band coil unit, fitted with our latest iron cored high "Q" coils, completely screened. A.V.C. Magic eye tuning indicator. Measurements $9\frac{1}{2} \times 8\frac{1}{2} \times 1\frac{1}{2}$ in. high.

We honestly believe this to be the finest tuning heart on sale, for sensitivity, selectivity, and the high fidelity obtained on the medium wave-band, due in measure to the cathode follower detector valve with its distortionless output, in conjunction with its filter system.

Price £25 including purchase tax.

Still giving satisfaction in five continents. Our well-tested, world renowned

CIRCUIT NO. 20

A 10-valve superheterodyne circuit with R.F. stage, six wave-bands, 5-2,000 metres, push-pull output for radio and gramophone. Full specification for those interested. Two full-size practical and one theoretical blue-prints, and priced list of parts. Price 7/6d. per set.

OUR SIX WAVE-BAND COIL UNIT

5-2,000 metres, completely wired up, as used on our No. 20 circuit, and 6 wave H.F. unit. Price wired up, calibrated to our 6 wave-band dial, and tested. £8 2 6. including purchase tax. Complete in every detail, in kit form, together with the necessary blue print.

Price **£5 10 0**

307, HIGH HOLBORN.
LONDON W.C.1. Phone: HOLborn 4631

Unbiased

Oyez

MOST of us suffer to greater or lesser degree from one or more of the infirmities of age long before we approach the Psalmist's three score years and ten. It is then that we summon science and Mr. Bevan to our aid to equip us with dentures and deaf-aids, to say nothing of spectacles and wigs. Of these, the hearing-aid is undoubtedly the Cinderella and the only one with which I am concerned as it alone depends on a radio-begotten technique for its operation. Now this device has of recent years made great strides from a technical point of view, but from the all-important aesthetic one it shows little advance on the formidable-looking ear trumpet which our grandparents used to direct at us when conversationally inclined. This is in marked contrast to our aids to vision which are designed to enhance rather than impair such beauty as we possess.

In the case of hearing-aids, however, we still seem tied to an entangling wire leading from our ears to other parts of our person on which are concealed microphone, amplifier and batteries which spoil the "line" of our gent's summer suiting. Now in the case of our aids to vision all the apparatus is carried neatly in front of our eyes where, of course, it should be, and I can see no reason at all why all the apparatus of our auditory aids should not be housed on our ears.

It may seem a very tall order to endeavour to mount battery, amplifier and mike

Hearing-Aid of the Future.

on our ears, but actually it is nothing of the kind. In far-off Melanesia much bulkier articles are carried in the ear lobes as I briefly mentioned last month. I myself have seen such knick-knacks as pipes, matches and quarter-pound tins of tobacco carried in this manner. This is done by piercing the ear lobes, ear-ring fashion, in early youth and then enlarging the hole with a wooden plug and later a springy twig of wish-bone shape so that eventually a narrow strip of flesh hangs down.



Whatever men may say, women at least could have no objection to carrying hearing aids in this way for they already mutilate themselves to wear ear-rings and they might just as well carry something useful as well as ornamental. No doubt our manufacturers could easily develop amplifier and battery containers in cylindrical form with a groove round the periphery into which the strip of flesh could be stretched as I endeavour to show in my illustration. Parents might treat their children's ears in this fashion as a sort of insurance policy against the infirmities of old age; even if never required the ear-lobe carrier would be useful for holding the ever-increasing burden of documents which our bureaucrats require us to carry about with us.

I need hardly say that women with their craze for fashion could insist on an alteration in shape or colour every year and there would thus be an almost bottomless well of fresh trade to warm what Sir Stafford Cripps would probably call his *Cochleae Cardis*.

Womanproof

AS most of you who have visited Radiolympia in bygone years will know, technical information from some manufacturers' stands has always been, what in modern jargon is called, in short supply. In fact, I could go so far as to say that in the case of certain firms who ought to know better it is easier to obtain an intelligent answer from a Government Department than from their representatives at the exhibition. One particular manufacturer to whom I complained about this state of affairs frankly admitted it and told me that the reason was that statistics prepared by his sales research department showed that only a very small percentage of buyers cared a bishop's tut-tut about the technical details of a receiver.

He further told me that in most cases it was the woman or women of the household who had the final say in the choice of a new set. His research laboratories have therefore been bending all their energies during the past year toward the production of a set which was not only pleasing to the ladies but was in all respects womanproof. Special attention had, he said, been paid to the question of accurate tuning which was as much a stumbling block to

them as was noiseless gear changing to the motor manufacturer.

My informant considers that the fundamental mistake hitherto made by manufacturers was in marking their tuning scales in metres, kilocycles or station names. The two former meant just nothing to the average woman while the latter

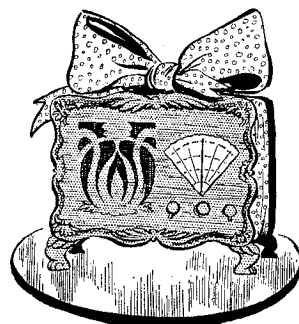

Pleasing the Ladies.

meant very little more, and he soon realized that what was wanted was a scale marked with such things as "Mrs. Dale's Diary," and "Sentimental Slush." Unfortunately he had encountered difficulty with the B.B.C. who had refused to accept his suggestion to put all the slush on one wavelength instead of scattering it all over the scale.

Finally, he tells me, he has solved his problem by remembering a suggestion I made some years ago. It was, that the time had come for us to give up referring to dress materials by such foolish terms as "a delicate shade of blue" and adopt instead a precise scientific description of the myriad shades of colour in the visible spectrum by referring to their wavelength in Angstrom units. He intends to reverse my suggestion and deliberately pander to women's love of describing colours with their customary circumlocutory verbosity instead of the plain and precise A.U. for which I had pleaded. He proposes to sweep his tuning scales clear of all names and numbers and simply change it from violet to red by almost infinite graduations of shade. He will then issue a chart showing in descriptive colour terms exactly where a particular programme is to be found on the scale. Mrs. Dale, for instance, being simply labelled "Alice-blue" or some such nonsense. By this means he hopes to sweep the market at the forthcoming exhibition to such an extent that all other manufacturers will be sweeping the streets.

LETTERS TO THE EDITOR

Contrast Expansion Problems ♦ B.B.C. Television in Holland ♦ "Exporting" Broadcast Channels ♦ What is "Strobing"?

"Contrast Expansion"

THIS article in your June issue of *Wireless World* prompts me to draw attention to an important design parameter to which the author did not refer; viz., the frequency/gain characteristic of the auxiliary amplifier feeding the rectifier producing the gain-controlling voltage. It is, of course, a fundamental requirement of the contrast amplifier that the output should not include any component of the gain-controlling voltage waveform (as pointed out by the author when discussing Langford Smith's circuit). This requirement is most readily met by designing the auxiliary amplifier to have low gain at all frequencies below that whose period is at least several times that of the time constant for the increase in gain of the system. Assuming with the author that the optimum value of the latter is 20/25 milliseconds, the auxiliary amplifier should provide low gain at all frequencies below, say, 250 c/s. This condition is obtained by reducing C_2 in Fig. 5 from 0.1 μ F to 330 pF.

Besides improving the low frequency transient response this modification will ensure that the gain of the contrast amplifier is dependent more upon the apparent loudness of the signal than upon the energy level, which may be greatest in the bass frequencies. G. MITCHELL.

I HAVE read with interest the article by L. J. Wheeler in the June *Wireless World*, and should like to offer some comments on the section referring to the use of negative feedback.

Examination of Fig. 4 of the article shows that the feedback from anode to cathode is not negative. In order that it should be so, it would be necessary to introduce either a transformer or an extra amplifying stage to obtain a further 180° phase shift.

It was, therefore, surprising to find what at first sight appeared to be this circuit used in Fig. 5, and, according to the table of results, used successfully. However, Mr. Wheeler's reference to my device for avoiding current feedback in the first stage of my expander gave the necessary clue. As Mr. Wheeler arranges the circuit, not only is current feedback avoided, but also the voltage feedback from the anode

circuit. The output of V_1 is developed between its anode and the junction of R_{10} and R_{11} , no part of the alternating anode current passes through R_{10} , and V_{2a} is simply a variable shunt across these points. The gain of V_1 is substantially $g_m R_L$, where R_L is the effective anode load and includes the impedance of V_{2a} , which varies with its bias and so produces expansion. This explains, of course, why Mr. Wheeler found a pentode desirable as V_1 . The only effects of R_{10} are to introduce a very small amount of negative feedback in the screen circuit of V_1 , because C_2 is returned to earth and not to the low-potential end of R_{11} , and to set up a hum voltage between control grid and cathode of V_1 from any residual ripple in the h.t. supply.

In order to check these conclusions, an amplifier was set up and consisted of V_1 and its associated components, using Mr. Wheeler's values, but with a variable resistance in place of V_{2a} , and with C_2 connected to avoid the secondary screen circuit feedback. The gain was measured with high and low values of "feedback" resistance and then the measurements were repeated with R_{10} short-circuited. For a given value of feedback resistance there was no difference in gain whether R_{10} was in circuit or shorted and, therefore, no difference in the ratio of gains for different values of "feedback" resistance. Thus R_{10} is not essential to the circuit, the analysis given above is justified, and Mr. Wheeler's claim that the circuit is an example of a "negative feedback" expander fails. Returning C_2 to earth produced no effect invalidating these conclusions.

Certain secondary comments seem pertinent. While it is true that a pentode, unlike a triode, will work satisfactorily with widely different values of anode load, it is still necessary that the a.c./d.c. ratio should be as high as possible, in order that harmonic distortion may be kept small. Admittedly, in Mr. Wheeler's circuit, the load ratio increases with the signal input to V_1 , but it is a consideration which may constitute a limiting factor in the application of the circuit.

Mr. Wheeler advocates, as I did, a standing bias on the variable impedance valve. He does this in order to avoid the small range over

THE ANTIFERRENCE D.5. THREE ELEMENT TELEVISION AERIAL

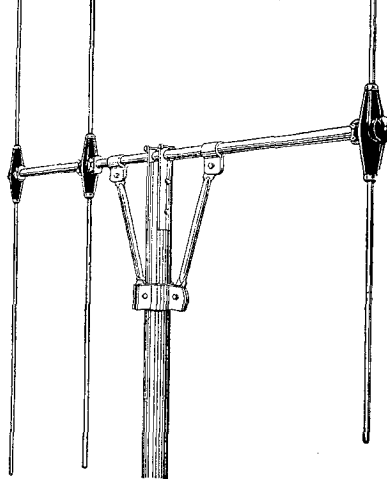

FOR LONG RANGE RECEPTION
All connections enclosed and sealed
against corrosion

The D.5 Aerial is designed for Television reception at long range. In addition to the normal dipole and reflector rods, a third element—the Director—is mounted on the supporting arm and positioned between the dipole and the transmitting station. The addition of this director element results in extra gain of signal and much improved directional properties. The aerial may also be used in stronger signal areas where extra directivity is required to eliminate ghost images or to minimise interference.

The Antiferrence Junction Units (Prov. Pat.) provide ample support for the aerial rods and a high degree of insulation in all weathers. All electrical connections are completely weathertight, preventing any possible deterioration in performance. The adjustable mast cap enables any size mast to be used, but a minimum of 2½ in. diameter is recommended. Mast mounting brackets are available for either lashing to a chimney (LSG/2) or bolting to any flat surface (SMB/2). The signal gain of the D.5 Aerial compared with that of a standard dipole is approximately 7dB (2-1).

Cat. No. for London D5. LIST PRICE £6.

Cat. No. for B'ham D5/B. LIST PRICE £6.

ANTIFERRENCE

LIMITED

67 BRYANSTON ST., LONDON, W.1.

Letters to the Editor —

which gain changes slowly with increase of signal. He then arranges for a variable delay on the rectifier circuit so that the onset of expansion may be delayed until the signal reaches a certain level. I should have thought that this was throwing away on the swings what had been gained on the roundabouts.

Mr. Wheeler uses a full-wave circuit to obtain the control voltage, and this is an arrangement which is well worth while, as the a.f. ripple on the resultant d.c. is at twice the frequency of the fundamental and may, therefore, be reduced to the required extent by the use of a filter circuit of lower time constant than would be needed after a half-wave rectifier.

In conclusion, and in case Mr. Wheeler's references to my articles may revive interest in them, they appeared in the issues of your journal for September and October, 1945, and April, 1946, not in those quoted in your footnote.

J. G. WHITE.
Leatherhead, Surrey.

A. P. in Holland

AS regular reader of *Wireless World* I have pleasure in informing you that I nearly every night have good reception of the B.B.C. television in my home at Delft. As the distance is more than 330 kilometres I think that the results are not bad.

Perhaps some details of the receiver are worth publishing as I think long-distance reception is always interesting.

As synchronization splitter I use a ECC40. The frame time-base is a ECC40 as squegging oscillator and

cathode-follower and after that 2 EF40s as deflection push-pull amplifiers.

The line time-base has also a ECC40 as blocking oscillator and 2 EF40s in push-pull. The picture tube is a war-surplus VCR97

For reception of the Philips experimental television transmitter at Eindhoven, Holland, which I receive with the same receiver I use a separate radio-frequency amplifier and oscillator (mixer). Also I have to change the detector for the negative modulation, and to turn the potentiometer knob of the blocking oscillator to get the right line frequency for Eindhoven.

J. TH. VAN REYSEN.
Delft, Holland.

Blocking Oscillators

I THINK W T Cocking overstates his case when he says that a blocking oscillator is now almost standard for television time base generation (*Wireless World*, June, 1949). Very many set-makers, both large and small, use thyratrons for this purpose.

The thyatron provides a very elegant method of time base generation which avoids the cost of a transformer and allows for synchronization with very small voltages.

K. S. PHILLIPS.
Edison Swan Electric Company,
London, W.C 2

B.B.C. Coverage

THE better B.B.C. service for the South Coast for which D. C. Smith pleads in your July issue could easily be provided under the Copenhagen Plan if the two medium-wave channels to be used

OUR COVER

TELEVISION TESTS—The operator, shown in the illustration on the front cover of this issue, is wearing a binocular magnifier lens for checking focus and interlacing on a Ferranti receiver. The test pattern is obtained from a picture generator. This visual check is made immediately after the set has been aligned and preparatory to its final test in its cabinet.

for political and propaganda broadcasts to Europe were applied to their proper use—distribution of broadcasting inside this country. I submit that these channels—incidentally they include one of our 3 exclusive frequencies — were not allocated to Great Britain for the purpose to which they are to be put.

Mr. Smith's suggestion for using the Kingston station for relaying the Home or Light Programme is good and apparently practicable, so far as it goes, but would provide only a palliative. A. ALFORD.
Worthing.

Calibrating a Wobbulator

I AM afraid Mr. Gibson (July issue) has been anticipated in his discovery as the American technical Press has for some months carried advertisements for "F.M. and T.V. sweep generators with built-in marker sig. gen."

Incidentally, I can't accept the term "strobing" for this use of a marker signal.

There is a faint analogy to an early radar system in the aspect of the trace, but the only "strobe" effect present is that which the system shares with all apparently stationary c.r.o. traces.

It would be interesting to know if there is an official definition.

It is not too easy to frame a really elegant one that includes the essentials of mechanical and electronic systems and those dependent on persistence of vision as well as "long-persistence screen" types.

Chester. R. C. WINDSOR.

Car Radio

ON technical grounds may I press for the abolition of the separate licence for a car radio?

This step would at once lead to a great increase in all-round efficiency due to the installation of the more efficient rod aerial in lieu of the less obtrusive running board type.

ROBERT C. BELL.
Ambleside.

**Books Published for "Wireless World"**

	Net Price	By post
RADIO VALVE DATA. Characteristics of 1,600 Receiving Valves	3/6	3/9
FOUNDATIONS OF WIRELESS. Fourth revised Edition, by M. G. Scroggie, B.Sc., M.I.E.E.	7/6	7/10
RADIO LABORATORY HANDBOOK. Fourth Edition, by M. G. Scroggie, B.Sc., M.I.E.E.	12/6	12/11
WIRELESS SERVICING MANUAL, by W. T. Cocking, M.I.E.E., Seventh Edition	10/6	10/10
TELEVISION RECEIVER CONSTRUCTION. A reprint of 10 articles from "Wireless World"	2/6	2/9
HIGH-QUALITY AUDIO AMPLIFIERS. Popular circuits reprinted from "Wireless World"	2/6	2/9
RADIO DATA CHARTS, by R. T. Beatty, M.A., B.E., D.Sc., Fourth Edition—revised by J. McG. Sowerby, B.A., Grad.I.E.E.	7/6	7/11
HANDBOOK OF TECHNICAL INSTRUCTION FOR WIRELESS TELEGRAPHERS, by H. M. Dowsett, M.I.E.E., F.Inst.P., and L. E. Q. Walker, A.R.C.S., Eighth Edition	30/-	30/8
WIRELESS DIRECTION FINDING. By R. Keen, M.B.E., B.Eng. (Hons.), Fourth Edition	45/-	45/9

Obtainable from all leading booksellers or from

ILIFFE & SONS LTD., Dorset House, Stamford Street, London, S.E.1.

SHORT-WAVE CONDITIONS

June in Retrospect : Forecast for August

By T. W. BENNINGTON and L. J. PRECHNER (Engineering Division, B.B.C.)

DURING June, maximum usable frequencies for this latitude decreased considerably by day and increased at night in accordance with the normal seasonal trend. Consequently the difference between the day and night value of m.u.f.s was quite small. The month was less disturbed than May, ionosphere storms being observed on 1st, 4th, 8th, 12th, 16th, 19th, 26th and 30th. The period 5th to 6th, during which a severe magnetic storm was recorded, was exceptionally disturbed.

Working frequencies for the month were generally very low and long-distance communication on the 28-Mc/s band was seldom possible, except on a few southerly circuits. During the night no frequencies below 7 Mc/s were really necessary. The rate of incidence of Sporadic E was very high and, as forecast in this column, transmissions on frequencies as high as 60 Mc/s were occasionally received via this layer.

Two "Dellinger" fadeouts, neither of which was particularly severe, were recorded in June—on 16th and 17th. Sunspot activity in June was considerably greater than in May. Three large sunspot groups crossed the central meridian of the sun (on 5th, 16th and 28th), the disturbances associated with the first group being particularly intense.

Long-range tropospheric propagation was very prevalent, particularly in the second half of the month, probably owing to the long periods of anticyclonic weather conditions.

Forecast.—During August the working frequencies for long-distance transmission will tend to be a little higher than those for July during the day-time and a little lower by night, thus the working frequencies for long-distance transmission will probably still be relatively low by day and high by night. Communication on very high frequencies (like the 28-Mc/s band) is not likely to be very frequent. However, towards the end of the month they may begin to become more useful, particularly in the southerly directions. Over many circuits fairly high frequencies, such as 15 Mc/s, will remain regularly usable until midnight. During the night, frequencies lower than 11 Mc/s will seldom be required. For medium distances up to about 1,800 miles E and F₁ layers will control transmission.

Sporadic E is usually very pre-

valent in August, although rather less so than during July. Communication over distances up to 1,400 miles may be possible by way of this medium on frequencies greatly in excess of the m.u.f.s for the regular E and F layers, and frequencies as high as 60 Mc/s may be occasionally reached for a short time. Owing to the irregular behaviour of the Sporadic E it is impossible to predict when such communication may occur.

Below are given, in terms of the broadcast bands, the working frequencies which should be regularly usable during August for four long-distance circuits, running in different directions from this country. All times are G.M.T. In addition, a figure in parentheses is given for the use of those whose primary interest is the exploitation of certain frequency bands, and this indicates the highest frequency likely to be usable for about 25 per cent of the time during the month, for communication by way of the regular layers:—

Montreal :	0000	11Mc/s	(16Mc/s)
	0200	9 "	(13 "
	0900	11 "	(16 "
	1100	15 "	(20 "
	2300	11 "	(16 "
Buenos Aires :	0000	11Mc/s	(17Mc/s)
	1000	15 "	(21 "
	1100	17 "	(24 "
	1200	21 "	(28 "
	2000	17 "	(23 "
Capetown :	0000	15Mc/s	(20Mc/s)
	0200	11 "	(16 "
	0600	17 "	(24 "
	0800	21 "	(28 "
	2000	17 "	(23 "
Chungking :	0000	9Mc/s	(14Mc/s)
	0400	11 "	(16 "
	0600	15 "	(20 "
	1000	17 "	(23 "
	1600	15 "	(19 "
1900	11 "	(15 "	
2300	9 "	(14 "	

Ionospheric storms are not usually very prevalent during August, but at the time of writing it would appear that storms are more likely to occur during the periods 6th-7th, 21st-23rd and 25th-27th than on the other days of the month.

"Trader Year Book."—The 1949 edition of this old-established annual, which was first published in 1925, is the usual mine of information for those seeking details of radio and electrical manufacturers' addresses, trade names, receiver specifications, valve base connections, etc. Prepared by our associated journal *The Wireless and Electrical Trader*, it is published by the Trader Publishing Co., price 10s 6d.

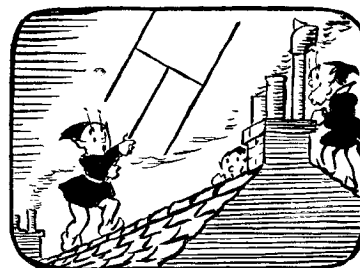

THE "FLUXITE QUINS" AT WORK

"Fixing with FLUXITE," cried EE,
 "Is the easiest job, I can see.
 But this part of the prank
 Is like walking the plank.
 Why they want 'em on roofs beats me!"

See that FLUXITE is always by you—in the house—garage—workshop—wherever speedy soldering is needed. Used for over 40 years in Government works and by leading engineers and manufacturers. Of all Iron-mongers—in tins, 10d., 1/6 & 3/-.

TO CYCLISTS! Your wheels will NOT keep round and true unless the spokes are tied with fine wire at the crossings AND SOLDERED. This makes a much stronger wheel. It's simple—with FLUXITE—but IMPORTANT.

The FLUXITE GUN puts FLUXITE where you want it by a simple pressure. Price 2/6, or filled, 3/6.



FLUXITE

IT SIMPLIFIES ALL SOLDERING

Write for Book on the ART OF "SOFT" SOLDERING and for Leaflets on CASE-HARDENING STEEL and TEMPERING TOOLS with FLUXITE Price. 1d. each.

FLUXITE LTD.

(Dept. W.W.), Bermondsey Street, S.E.1

RANDOM RADIATIONS

Cosines Without Tears

THE JULY NUMBER of the New York *Radio-Electronics* contains a useful tip for obtaining sine and cosine values—when you haven't a book of trig tables handy—of angles which are integral multiples of 10 degrees. All that you need do is to memorize the series of numbers 2, 4, 8, 10, 12, 14, 16, 17, 17. Not a difficult business for it means simply the even numbers up to sixteen, with six left out, and then a couple of seventeens. You will observe that the first six add up to 50 and the whole lot to 100. To find $\cos 10^\circ$ subtract the first number from 100; for $\cos 20^\circ$ subtract the sum of the first two; for $\cos 30^\circ$, the sum of the first three, and so on. Put a decimal point in front of the result and there you are. Thus:

For $\cos 10^\circ$, $100 - 2$ gives 0.98.

For $\cos 20^\circ$, $100 - (2 + 4)$ gives 0.94.

For $\cos 30^\circ$, $100 - (2 + 4 + 8)$ gives 0.86.

And so on to $\cos 80^\circ$, when $100 - (2 + 4 + 8 + 10 + 12 + 14 + 16 + 17)$ gives 0.17. Compare these values with those of a trig table and you'll find that their accuracy (better than $\pm 2\%$) is quite good enough for everyday electrical calculations. In point of fact it is amply sufficient for the bulk of one's normal work on a.c. problems. Sines of angles are found just as easily, since $\sin \phi = \cos (90^\circ - \phi)$. Thus, if you want $\sin 50^\circ$, all you have to do is to find $\cos (90^\circ - 50^\circ) = \cos 40^\circ$ in the way suggested: $100 - (2 + 4 + 8 + 10)$ gives 0.76.

Interpolation

The method may also be used with quite remarkable accuracy for finding the cosines and sines of angles which are not integral multiples of 10° . Suppose, for instance, that the wanted cosine is that of 56° . For $\cos 50^\circ$ we have $100 - (2 + 4 + 8 + 10 + 12)$ which gives 0.64. But for 56° we must also subtract 6/10, or 0.6, of the next number in the series, 14. Hence we have $100 - (2 + 4 + 8 + 10 + 12 + 8)$, which gives 0.56—and that doesn't compare badly with the 0.559193 of a six-figure table. Or we might want to find $\sin 63^\circ$. $\sin 63^\circ = \cos 27^\circ$. Then we have $100 - (2 + 4 + [0.7 \times 8])$, which gives, to

By "DIALLIST"

two figures, 0.88. The six-figure tables show the value as 0.891007, so again we haven't done too badly. In practice any of these calculations can, of course, be made in one's head in far less time than it takes to describe the steps involved. To me, at any rate, the idea is quite new, though I fully expect to hear from some reader who is versed in the history of mathematics that it dates back to the time of Archimedes, or before. Can anybody suggest a method for obtaining tangents which is as easily memorized and as simple to use.

Rough on Rats

THE SAME JOURNAL quotes an apparently authenticated account of the successful use of magnetic wire recording to deal with a plague of rats! No, it wasn't on Pied-Piper-of-Hamelin lines; and yet, perhaps one part of the process was, in a way. A warehouse in Vancouver, British

COMMERCIAL ULTRASONIC GENERATOR

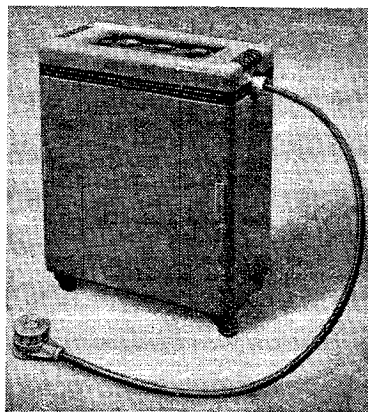

Capable of producing 1 kW of ultrasonic power at nominal frequencies of 0.25, 0.5, 1 and 2 Mc/s this generator is mounted on a trolley for ease of transport. The quartz crystal transducer is air-backed to give maximum radiation in a forward direction and is coupled to the oscillator by a coaxial cable. Silver electrodes, fired on both sides of the crystal, are used to establish the electric field. The makers are Mullard Electronic Products, Aboynne Road, London, S.W.17.

Columbia, was infested by rats, which were doing a great deal of damage. The manager, owned a wire recorder and decided to see whether something could not be done with its aid. Rats, he knew, will set up speed records in their dash for the horizon if they hear the warning squeaks of their fellows. He caught two or three in a cage trap, placed a microphone near the contrivance and proceeded to prod and harry its occupants until they were squeaking with fright. Next, he played back his record over the p.a. system of the warehouse. The result, he declares, was a positive stampede. Rats of all ages and sizes emerged from every hole and made as fast as their legs would carry them for the great open spaces. The trouble was that unless the record was kept playing, which was more than human flesh and blood could stand, the rats came back. Another method was evolved and this is where the Pied Piper part of the business came in. It is well known to professional ratcatchers, or rodent officers as they are now officially called, that male rats respond instantly, though not with purely altruistic motives, to the squeaks of distress of female rat. The cries of a few trapped females were recorded and played back over the p.a. loudspeakers. This produced just the opposite of the previous breakaway. Male rats appeared from everywhere and converged on the loudspeakers so purposefully that they offered easy targets. I'm wondering whether a campaign on similar lines would help me to combat the legions of mice which this year have dug up and eaten vegetable seeds almost as fast as I have been able to sow them in my garden.

'Ware Strobing

GLANCING RECENTLY through a book written for amateur workshop enthusiasts, I was disturbed at finding an unqualified recommendation of fluorescent lighting for workshop use. The fluorescent lamp has no more ardent supporter than myself; I would not for anything be without the "daylight" example by the light of which I do most of my reading and writing of nights. But *not* in the amateur workshop,

for there it may be a dangerous thing to use. The reason is that these lamps actually throw a flickering light, cutting out at each zero point of the a.c. mains voltage. The flickers are much too rapid (2f, or 100 per second in this country) to be perceptible to the eye. But in the workshop they can give rise to stroboscopic effects, which may make rapidly revolving or reciprocating machine tools appear to be motionless. In factories, where 3-phase a.c. is nearly always available, since the 3-phase induction motor is by far the most widely used of electrical turners of the wheels of industry, this snag is easily avoided. The usual practice is to mount fluorescent lamps in banks of three, each tube being connected to a different phase of the mains supply. The amateur, though, has seldom, if ever, more than a single phase at his command and he should, therefore, be duly on his guard against the risks which strobing may involve. If you don't believe me, take an ordinary hand-driven emery wheel, fix it to a table beneath a fluorescent light and gradually work up the revs, getting a friend to observe what happens. You can see something of the strobing effect if you watch an electric fan illuminated by a fluorescent lamp. Its blades never appear quite motionless in the induction motor which drives it has always some "slip" —it couldn't work if it hadn't. Its rate of revolution is, therefore, a little less than an integral sub-multiple of the frequency applied to both it and the lamp and perfect strobing cannot take place. Still, you will obtain, especially if your eyes are a little tired, the impression of rather indistinct blades moving slowly backwards, like the spokes of motor car wheels in old-time ciné films.

Treating 'em Rough

THE SPECIFICATION recently brought out by the Radio Industry Council for climatic and durability tests of radio and other electronic components makes interesting reading. I should emphasize, by the way, that the specification is the Council's own private product and has not yet reached the stage of being considered by the British Standards Institution. The tests outlined are of so exacting a nature that they should ensure a very high standard of performance

25 YEARS *Switch* EXPERIENCE

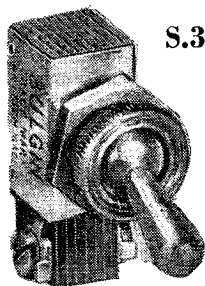

S.356

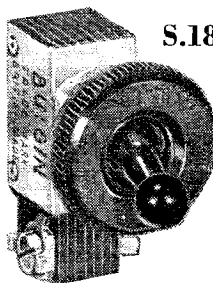

S.185

Types—

- SINGLE POLE
- DOUBLE POLE
- MAKE-BREAK
- CHANGE-OVER
- BIASED
- KEY-OPERATED
- PUSH-PULL
- TOGGLE
- ROTARY
- SEMI-ROTARY

FINISHES
AVAILABLE FOR ALL SWITCHES

DOLLIES—



PEAR



FORKED



BALL

RINGS & NUTS—



KNURLED



PLAIN



HALF-DOMED



PLASTIC



SLOTTED



BEVELLED

BUSHES—



SHORT



MEDIUM



LONG

● DOLLY AND RING FINISHES

AVAILABLE IN



25,000 OPERATIONS GUARANTEED!

BULGIN

MINIATURE

SWITCHES

A. F. Bulgin & Co. Ltd., Bye Pass Road, Barking, Essex.

Telephone: RIPpleway 3474 (5 lines)

Random Radiations—

under the most adverse conditions by British-made components. Take the "salt-atmosphere test"—six hours in a closed cabinet with a spray (not directed straight at the component) atomizing a solution of sodium chloride, magnesium chloride, calcium chloride and potassium chloride; then 18 hours with the spray off and the cabinet open. Repeat the cycle three times. I'm particularly taken by the design of the special bumping machine. In fact I'm wondering whether, to judge from the condition of some of

the parcels I receive, the Post Office has not had a "super" model in use for some time! The R.I.C. bumping machine is a gem of fiendish ingenuity. The component under test is fixed to a wooden platform, hinged at one end to a support. Fifteen inches from the hinge a square spindle with 1in faces turns at a speed of 120 revolutions a minute under the free end of the platform. If a component can stand up to the prescribed eight minutes of that, or $8 \times 4 \times 120 = 3,840$ hefty bumps, it should be able to smile at normal rough handling.

current only, so that the indicating needle remains at zero; but any deviation from course will deflect the needle either to port or starboard.

The Decca Record Co., Ltd., and W. J. O'Brien. Application date, April 15th, 1946. No. 610954.

Receiver for F.M. Signals

THE anode of the limiter valve is connected to two parallel-resonant circuits, arranged in series relation, one being tuned to the carrier frequency, and the other to double that frequency. These are coupled to a pair of secondary circuits, similarly arranged and similarly tuned, and shunted across two oppositely-poled diode rectifiers.

The coupled network of resonant circuits acts as a phase-shifting device which, so long as no signal is present, produces an output wave that is symmetrical in form and so balances out across the rectifiers. Any departure from resonance, due to the appearance of a signal, will upset the normal quadrature phase relationship between the couplings, to an extent and in a sense which depends upon the original signal. The resulting output is a waveform of corresponding asymmetry, from which the signal is readily extracted by the diode rectifier.

Marconi's Wireless Telegraph Co., Ltd. (assignees of W. L. Carlson). Convention date (U.S.A.) May 22nd, 1945. No. 612448.

Television Safeguard

SO long as the electron stream is kept in rapid movement over the picture raster, under the influence of the line and frame scanning deflectors, there is no danger of damage to the fluorescent screen of the cathode-ray tube. But should one or other of the scanning generators fail, the sharply focused stream either becomes subject only to the comparatively slow-moving frame voltage, or else makes repeated traverses along the same scanning line. In both cases the sensitive coating of the screen is likely to be badly burnt.

According to the invention, the electron stream is automatically swept off the fluorescent screen should either of the scanning generators fail. While, say, the line-scan generator is in operation, the intermittent flow of its grid current serves to develop a negative potential. This is used to apply a cut-off bias to the grid of an auxiliary valve arranged in series with the frame deflecting coil. When the cut-off bias fails, the auxiliary valve at once releases sufficient current to sweep the focused stream completely off the screen. A second auxiliary valve similarly supervises the running of the frame-scan generator.

A. C. Cossor, Ltd.; A. H. A. Wynne and M. France. Application date, March 7th, 1946. No. 609839.

RECENT INVENTIONS

A Selection of the More Interesting Radio Developments

Short-wave Amplifiers

THE invention, which claims an early priority date, is based on the fact that effects associated with the presence of inductance in the supply leads to a short-wave amplifier can, within limits, be offset by providing

reactance such as a magnetron or similar valve of the space-charge or braking-field type. Such valves show an apparent capacitance particularly in the neighbourhood of their inherent resonance, which is highly sensitive, in the case of the magnetron, to small changes of anode potential.

In one arrangement, a waveguide terminating in a flared radiator is coupled through a coaxial line to a magnetron to which television signals are separately applied. The resulting changes in capacitance control the flow of waves towards the radiator to an extent that varies from the normal maximum to a complete cut-off.

A carrier wave of several hundred watts can be fully modulated in this way by signal energy of the order of one watt. Moreover, the method does not tend to damp or otherwise affect the frequency stability of the main generator.

Cie Generale de Telegraphie Sans Fil. Convention date (France), February 6th, 1945. No. 611931.

Indicators for Radio Navigation

RELATES to approach and blind-landing systems of the overlapping-beam type in which complementary signals are radiated in morse alternately in a given time cycle to produce an equi-signal zone marking out a desired course and having distinctive signals to port and starboard of it.

According to the invention, a visual indication of such signals is secured by feeding them to the grid of a rectifier tube, the anode of which is also coupled to a local oscillator, so that a pulsating output appears only during the intervals when both the grid and anode are positive with respect to the cathode. After amplification, this output is applied to a first pair of half-wave rectifiers, and then through a low-pass filter to an auto-transformer, which feeds a second pair of rectifiers controlling a zero-centre galvanometer. So long as the aircraft is "on course," the auto-transformer receives a direct

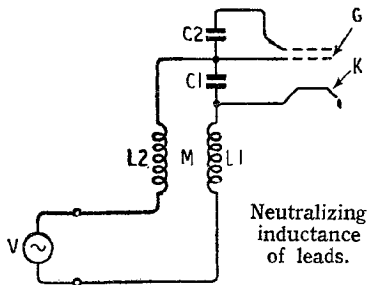

mutual coupling between certain of the leads.

In the diagram, the inductance L_1 of the supply wires to the cathode K is closely coupled at M to the inductance L_2 of the wire leading to the control grid G , the interelectrode capacities of the amplifier being represented at C_1 and C_2 . When an input signal is applied at V , the back e.m.f. developed through the coupling M reduces the value of the circulating current that would otherwise bypass the amplifier. The value of M must be at least half that of L_1 , which in turn should not exceed 0.04 microhenrys. Various devices are described for securing the necessary degree of close coupling between the supply leads.

Philips Lamps, Ltd. Convention date (Netherlands), September 14th, 1939. No. 612651.

Systems of Modulation

CENTIMETRE waves flowing through a waveguide are modulated in amplitude by varying the normal coefficient of transmission of the guide through the agency of a variable

The British abstracts published here are prepared with the permission of the Controller of H.M. Stationery Office, from specifications obtainable at the Patent Office, 25, Southampton Buildings, London, W.C.2, price 2/- each.